



15370 Barranca Parkway
Irvine, CA 92618-2215
USA

DTC4500 User Guide



P/N: L001444, Revision 1.1

DTC4500 Card Printer/Encoder User Guide (Rev 1.1), © 2011 property of HID Global Corporation. All rights reserved.

Exclusive permission is granted to authorized resellers of HID Global products to reproduce and distribute this copyrighted document to authorized HID Global customers, who have signed a no disclosure agreement regarding the restricted, proprietary use of said document.

The revision number for this document will be updated to reflect changes, corrections, updates and enhancements to this document.

Revision Control Number	Date	Document Title
Revision 1.1	January 2011	DTC4500 Card Printer/Encoder User Guide
Revision 1.0	August 2010	DTC4500 Card Printer/Encoder User Guide

Trademarks and Disclaimers

HID, HID Global, and Fargo are the trademarks or registered trademarks of HID Global Corporation in the U.S. and other countries.

The information contained in this document is provided AS IS without any warranty.

HID Global hereby disclaims all warranties and conditions with regard to the information contained herein, including all implied warranties of merchantability, fitness for a particular purpose, title and non-infringement.

In no event shall HID Global be liable, whether in contract, tort or otherwise for any indirect, special or consequential damages arising from the use of the information contained in this document.

Any questions regarding changes, corrections, updates or enhancements to this document should be forwarded to:

Hid Global
Support Services
6533 Flying Cloud Drive
Eden Prairie, MN 55344 (USA)
(866)607-7339 Ext #6
FAX: (952) 946-8492
www.hidglobal.com

Table of Contents

DTC4500 User Guide	1
Section 1: Specifications	5
Regulatory Compliances	5
Agency Listings	6
United States	6
Canada	6
Environmental Protection (China-RoHS)	7
Traditional Chinese RF Emissions and Safety Statements	7
Simplified Chinese	8
Safety Messages (review carefully)	9
Technical Specifications	10
Functional Specifications	14
Printer Components: Print Ribbons	14
Ribbon Types/Count Table	15
Printer Components: Blank Cards	16
Section 2: Setup and Installation Procedures	17
Choosing a Good Location	17
About Moisture Condensation	17
Unpacking and Inspection	17
Installing the Print Ribbon Cartridge (DTC4500)	18
Installing the Ribbon	18
Installing the Ribbon	19
Installing Blank Cards into the Card Hopper (DTC4500)	20
Using the Dual Hopper	20
Setting the Card Size for CR79 and CR80	23
Connecting the Printer power	27
Section 3: Print Driver Installation	29
Swift ID Installation Instructions	32
Installing Swift ID	34
Printer Installed On Network	35
Printer Connected Via USB Connection	37
Option No. 1	37
Option No. 2	37
Uninstalling Swift ID	38
Additional Swift ID Rules	38
Section 4: Printer Preferences Tab Functions	39
Using the Card tab	39
Using the Toolbox Options	40
Using the Configuration Tab	41
Using the Event Monitoring Group Box	41
Selecting the Calibrate Laminator tab	42
Selecting the Calibrate Ribbon tab	43
Selecting the Clean Printer tab	44
Selecting the Advanced Settings tab	45
Using the Device Options tab	53
Using the Image Color tab	56
Changing the Color Profile Selection for the DTC4500	59
Changing the Color Profile Selection for the DTC4500	60
Using the Image Calibrate tab	61

Using the Magnetic Encoding Tab _____	62
Using the Magnetic Encoding Tab – ISO Standards _____	63
Using the Magnetic Encoding Tab – Custom Encoding or Raw Binary Encoding Mode _____	65
Reviewing the ISO Track Locations _____	67
Sending the Track Information _____	68
Reviewing the ASCII Code and Character Table _____	69
Using the Lamination tab _____	71
Using the Overlay / Print Area tab _____	73
Using the K Panel Resin tab _____	76
Using the Printer Info tab _____	79
Section 5: Card Lamination Module. _____	80
Reviewing the Card Lamination Module _____	81
Choosing a Proper Location _____	81
Preventing Moisture Condensation _____	81
Installing the Laminates _____	82
Adjusting the Lamination Placement on the Card _____	86
Section 6: Selecting the Fluorescent Panel Ribbon Type _____	87
Creating a Custom Fluorescent Image (using the YMCFKO Ribbon) _____	87
Configuring Fluorescent Data (F-Panel for YMCFKO Ribbon) using the Application _____	89
Section 7: System Overview- Troubleshooting _____	93
Reviewing the DTC4500 Sequence of Operations _____	93
Reviewing the DTC4500 Sequence of Operations _____	94
Section 8: Troubleshooting _____	95
Printer Error Button and Display Message Table _____	95
Using the Error Message Table _____	96
Troubleshooting with the Error Message Table _____	98
Printer Specific Tools (DTC4500) _____	111
Additional Printer Specific Tools _____	113
Section 9: Cleaning _____	115
Safety Messages (review carefully) _____	115
DTC4500 Card Printer/Encoder Cleaning Kit _____	116
Supplies (included with the Cleaning Kit) _____	116
Printhead Cleaning _____	117
Cleaning the Platen and the Card Feed Rollers _____	118
Cleaning the Printer's Interior _____	122
Cleaning the Printer's Exterior _____	122
Section 10: Firmware Upgrades _____	123
Upgrade the Printer Firmware _____	123
Section 11: HID Global Technical Support _____	127
Reading the Serial Numbers on a Fargo Printer _____	128
Appendix A _____	129
Using the Defined Area Option _____	129
Configuring Fluorescent Data (F-Panel for YMCFKO Ribbon) using the Workbench _____	130

Section 1: Specifications

The purpose of this section is to provide you with specific information on the Regulatory Compliances, Agency Listings, Technical Specifications and Functional Specifications for the DTC4500 Card Printer User Guide.

Regulatory Compliances

Term	Description
CSA (cUL)	The Printer manufacturer has been authorized by UL to represent the Card Printer as CSA Certified under CSA Standard C22.2 No. 60950-1-03. IEC 60950-1 2 nd edition File Number: E145118
FCC	The Card Printer complies with the requirements in Part 15 of the FCC rules for a Class A digital device.
EMC	The Card Printer has been tested and complies with EN55022 / CISPR 22 Class A: and EN55024 standards. (Note: Based on the above testing, the Printer manufacturer certifies that the Card Printer complies with current EMC directive 2004/108/EC of the European Community and has placed the CE mark on the Card Printer.)
UL	The Card Printer is listed under UL 60950-1 (2 nd edition) INFORMATION TECHNOLOGY EQUIPMENT Note: This product is intended to be supplied by a Listed Power Unit marked Class 2 and rated for 24 V dc, 3.7 to 5A
Environmental	Power supply Efficiency level IV minimum. RoHS, China RoHS

Agency Listings

Term	Description
Emissions Standards	CE, FCCPart 15 Class A, CRC c1374, CISPR22 Class A, EN55022, EN55024, EN61000-3-2, EN61000-3-3,
Safety Standards	UL IEC 60950-1 (2001), CSA C22.2 No. 60950-1-03.

United States

This device complies with Part 15 of the FCC rules. Operation is subject to the following two conditions:

- (1) This device may not cause harmful interference.
- (2) This device must accept any interference received, including interference that may cause undesired operation.

Note: This equipment has been tested and found to comply with the limits for a Class A digital device, pursuant to part 15 of the FCC Rules. These limits are designed to provide reasonable protection against harmful interference when the equipment is operated in a commercial environment. This equipment generates, uses, and can radiate radio frequency energy and, if not installed and used in accordance with the instruction manual, may cause harmful interference to radio communications. Operation of this equipment in a residential area is likely to cause harmful interference; in which case, you will be required to correct the interference at his own expense.

Reference the Safety Messages in this document.

Canada

This Class A digital apparatus complies with Canadian ICES-003.

C'et appareil numerique de la classe A est conforme a la norme NMB-003 du Canada.



Caution: Changes or modifications not expressly approved by the party responsible for compliance could void the user's authority to operate the equipment.

Environmental Protection (China-RoHS)

环境保护(中国- RoHS)

Environmental Protection Use Period is based on the product being used in an office environment.

环保使用期限是基于本产品用于办公室环境

Traditional Chinese RF Emissions and Safety Statements

传统中文 射频放射及安全指令

安全信息 (小心检查)

标记	重要的安全事项说明安全
危险: 	未按照说明安装可能造成人员伤亡。 在可能产生潜在安全问题的地方有警示标记。(如左图所示)。 为了防范人员伤亡, 做带此警示标记的操作前, 参考安全信息提示。 为了防范人员伤亡, 在没有特别说明的情况下, 修理前关掉电源开关。
小心: 	此设备对静电很敏感。如果受到静电放电, 设备会被损害。 在可能产生潜在静电安全问题的地方有警示标记。(如左图所示)。 为了防范损害设备, 做带此警示标记的操作前, 参考安全信息提示。 为了防范损害设备, 在排放电路板和打印头联合装置里面或附近的电线时, 请注意观察所有的静电放电设备。 为了防范损害设备, 贴身佩戴合适的接地装置 (比如: 手腕上带一个高质量的接地皮带以免受到可能的伤害)。 为了防范损害设备, 如果没有特殊说明, 在做任何修理前, 请取下打印机上的色带和卡。 为了防范损害设备, 在使用打印机之前, 请摘下戒指和手上饰品, 仔细清洗手上的油脂。

經型式認證合格之低功率射頻電機, 非經許可, 公司、商號或使用者均不得擅自變更頻率、加大功率或變更原設計之特性及功能。低功率射頻電機之使用不得影響飛航安全及干擾合法通信; 經發現有干擾現象時, 應立即停用, 並改善至無干擾時方得繼續使用。前項合法通信, 指依電信法規定作業之無線電通信。低功率射頻電機須忍受合法通信或工業、科學及醫療用電波輻射性電機設備之干擾。

Simplified Chinese

如何使用本手册

实际上, DTC4500 证卡打印机用户指南

是一本整个证卡打印机的故障排除和服务手册。本手册旨在帮助安装人员和技术人员快速有效地查找相关过程、组件和术语。安装人员或技术人员可根据自己的喜好, 高效地使用本手册的电子文档或纸面文档。



安全消息(请仔细阅读)

符号	安全事项的重要说明
危险: 	<p>如果不遵循这些安装指南进行操作, 可能会导致重伤, 甚至死亡。</p> <p>可能引发安全问题的信息由警告符号(如左图所示)来表示。</p> <p>为了确保人身安全, 在执行前面带有此符号的操作之前, 请先阅读下面的安全消息。</p> <p>为了确保人身安全, 除非另有规定, 否则在执行维修过程前, 始终应断开电源。</p> <p>为了确保人身安全, 只能由有资格的人员执行这些过程。</p>

安全消息(请仔细阅读)

符号	安全事项的重要说明
小心: 	<p>此设备为静电敏感设备。如果暴露在静电电流下, 可能会损坏设备。</p> <p>可能引发静电安全问题的信息由警告符号(如左图所示)来表示。</p> <p>为了防止设备或介质受损, 在执行前面带有此符号的操作之前, 请先阅读下面的安全消息。</p> <p>为了防止设备或介质受损, 请在处理电路板和打印头部件中或附近的电缆时, 遵守所有规定的静电放电 (ESD) 过程。</p> <p>为了防止设备或介质受损, 请始终佩戴适当的个人接地设备(例如, 已接地避免出现潜在损坏的高质量腕带)。</p> <p>为了防止设备或介质受损, 除非另有规定, 否则在执行任何维修过程前, 始终应将色带和证卡与打印机分离。</p> <p>为了防止设备或介质受损, 在操作打印机前, 请取下手指和手上的珠宝首饰物, 并将手上的油渍和污渍彻底清洗干净。</p>

Safety Messages (review carefully)

Symbol	Critical Instructions for Safety purposes
<p>Danger:</p> 	<p>Failure to follow these installation guidelines can result in death or serious injury.</p> <p>Information that raises potential safety issues is indicated by a warning symbol (as shown to the left).</p> <ul style="list-style-type: none"> • To prevent personal injury, refer to the following safety messages before performing an operation preceded by this symbol. • To prevent personal injury, always remove the power cord prior to performing repair procedures, unless otherwise specified. • To prevent personal injury, make sure only qualified personnel perform these procedures.
<p>Caution:</p> 	<p>This device is electrostatically sensitive. It may be damaged if exposed to static electricity discharges.</p> <p>Information that raises potential electrostatic safety issues is indicated by a warning symbol (as shown to the left).</p> <ul style="list-style-type: none"> • To prevent equipment or media damage, refer to the following safety messages before performing an operation preceded by this symbol. • To prevent equipment or media damage, observe all established Electrostatic Discharge (ESD) procedures while handling cables in or near the Circuit Board and Printhead Assemblies. • To prevent equipment or media damage, always wear an appropriate personal grounding device (e.g., a high quality wrist strap grounded to avoid potential damage). • To prevent equipment or media damage, always remove the Ribbon and Cards from the Printer before making any repairs, unless otherwise specified. • To prevent equipment or media damage, take jewelry off of fingers and hands, as well as thoroughly clean hands to remove oil and debris before working on the Printer.

Technical Specifications

Term	Function
Print Method	Dye Sublimation / Resin Thermal Transfer
Print resolution	300 dpi (11.8 dots/mm); continuous tone
Colors	Up to 16.7 million colors / 256 shades per pixel
Print Ribbon Options	<ul style="list-style-type: none"> • Full-color with resin black and overlay panel, YMCKO*, 500 prints • Full-color half-panel with resin black and overlay panel, YMCKO*, 850 prints • Full-color with two resin black panels and overlay panel, YMCKOK*, 500 prints • Full-color with fluorescing, resin black and overlay panel, YMCFKO*, 500 prints • Full-color with fluorescing, two resin black panels and overlay panels, YMCFKOK*, 400 prints • Full-color with two resin black panels and overlay panels, YMCKK*, 500 prints • Resin black and overlay panel, KO*, 1250 prints • Dye-sublimation black and overlay print, BO*, 1250 prints • Resin black (standard and premium), 3000 prints • Resin green, blue, red, white, silver and gold, 2000 prints • Rewrite technology – No ribbon is required <p>* Indicates the Ribbon type and the number of Ribbon panels printed where Y=Yellow, M=Magenta, C=Cyan, K=Resin Black, O=Overlay, F=Fluorescing Resin</p>

Technical Specifications

Term	Function
Print Speed	<ul style="list-style-type: none"> • 7 seconds per card (K*) • 12 seconds per card (KO*) • 24 seconds per card (YMCKO*) • 31 seconds per card (YMCKOK*) • Print speed indicates an approximate batch print speed and is measured from the time a card feeds into the Printer to the time it ejects from the Printer. • Print speeds do not include encoding time or the time needed for the PC to process the image. <p>* Process time is dependent on the size of the file, the CPU, amount of RAM and the amount of available resources at the time of the print. Indicates the Ribbon type and the number of Ribbon panels printed where Y=Yellow, M=Magenta, C=Cyan, K=Resin Black, O=Overlay, F=Fluorescing Resin</p>
Card Size and Types Supported	<ul style="list-style-type: none"> • CR-80 (3.375"L x 2.1125"W / 85.6mmL x 54mmW) • CR-79 (3.313"L x 2.063"W / 84.1mmL x 52.4mmW)
Accepted Standard Card Sizes	<ul style="list-style-type: none"> • CR-80 edge-to-edge (3.36"L x 2.11"W / 85.3mmL x 53.7mmW) • CR-79 (3.3"L x 2.04"W / 83.8mmL x 51.8mmW)
<i>Accepted Card Thickness</i>	<ul style="list-style-type: none"> • Print Only: .009" - .040" / 9 mil – 40 mil / .229mm – 1.016mm • Print/Lamination: .030" - .040" / 30 mil – 40 mil / .762mm – 1.02mm

Technical Specifications

Term	Function
Accepted Card Types	PVC or polyester cards with polished PVC finish; monochrome resin required for 100% polyester cards; optical memory cards with PVC finish; rewrite
Input Hopper Card Capacity	Dual-Input Card Hopper (200 cards)
Output Hopper Card Capacity	100 cards (.030" / .762mm)
Reject Hopper Card Capacity	100 cards (.030" / .762mm) – same-side Input/Output Card Hopper or Lamination Module (required)
Card Cleaning	Card cleaning roller integrated into the Ribbon Drawer.
Printer Memory	32MB RAM
Software Driver	Windows® XP / Vista™ (32 bit & 64 bit) / Server 2003 & 2008 / Windows® 7 (32 bit & 64 bit) / Linux®
Interface	USB 2.0 and Ethernet with internal print server
Operating Temperature	65 degrees to 80 degrees F / 18 degrees to 27 degrees C
Humidity	20-80% non-condensing
Dimensions	<p>Single-Sided Printer: 9.8"H x 18.1"W x 9.2"D / 249mmH x 460mmW x 234mmD</p> <p>Dual-Sided Printer: 9.8"H x 18.7"W x 9.2"D / 249mmH x 475mmW x 234mmD</p> <p>Printer + Lam: 18.9"H x 18.7"W x 9.2"D / 480mmH x 475mmW x 234mmD</p>

Technical Specifications

Term	Function
Weight	Single-Sided: 9 lbs. / 4.1 Kg Dual-Sided: 11 lbs. / 5 Kg Dual-Sided: 20 lbs. / 9.1 Kg
Agency Listings	Safety: UL 60950-1, CSA C22.2 (60950-1), and CE; EMC; FCC Class A, CRC c1374, CE (EN 55022 Class A, EN 55024), CCC, BSMI, KCC
Supply Voltage	100-240 VAC, 1.6 A
Supply Frequency	50 Hz / 60 Hz
Warranty	Printer – Two years; Printhead – Two years, unlimited pass with UltraCard™
Encoding Options Supported	<ul style="list-style-type: none"> • 125kHz (HID Prox) reader • 13.56 MHz (iCLASS, MIFARE, ISO 14443 A/B, ISO 15693) read/write encoder • Contact Smart Card Encoder reads from and writes to all ISO7816 1/2/3/4 memory and microprocessor smart cards (T=0, T=1) as well as synchronous cards • ISO Magnetic Stripe Encoding, dual high- and low-coercivity, Tracks 1,2 and 3
Options	Single Wire Ethernet and USB 2.0 Interface for inline printing and encoding (Note: Single wire Ethernet encoding is only available for iCLASS and Contact Smart Card encoding); Dual-Sided Printing Module – Upgradable; Same-Side Input / Output Card Hopper – Upgradable; Smart Card Encoding (contact / contactless) – Upgradable; Magnetic Stripe Encoding – Upgradable; Printer Clearing Kit
Software	Swift ID™ Embedded Badging Application, FARGO Workbench Diagnosis Utility
Display	Color changing status buttons

Functional Specifications

This Card Printer utilizes two different, yet closely related printing technologies to achieve its remarkable direct-to-card print quality for dye-sublimation and resin thermal transfer.

Printer Components: Print Ribbons

The Card Printer utilizes both dye-sublimation and/or resin thermal transfer methods to print images directly onto blank cards. Since the dye-sublimation and the resin thermal transfer print methods, each provide their own unique benefits, Print Ribbons are available in resin-only, dye-sublimation-only and combination dye-sublimation/resin versions.

To make it easier to remember which Print Ribbons are which, a letter code has been developed to indicate the type of Ribbon panels found on each Ribbon. This letter code is as follows:



= Dye-Sublimation Yellow Panel



= Dye-Sublimation Magenta Panel

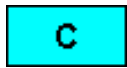

= Dye-Sublimation Cyan Panel



= Resin Black Panel (Premium unless otherwise stated)

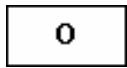

= Clear Protective Overlay Panel



= Fluorescing Panel

Ribbon Types/Count Table

Ribbon type and count used in each Printer.

Ribbon	DTC4500
YMCKO – Full Color/Resin Black/Overlay	500
YMCKO Half Panel – Full Color (1/2)/Resin Black/Overlay	850
YMCFKO - Full Color/UV Fluorescing/Resin Black/Overlay	500
YMCKK - Full Color/2 Resin Black	500
YMCKOK - Full Color/2 Resin Black/Overlay	500
YMCFKOK - Full Color/UV Fluorescing/2 Resin Black/Overlay	400
K – Standard Resin	3000
K – Premium Resin	3000
Colored Resin	2000
KO - Premium Black Resin/Overlay	1250
BO - Dye-Sub Black/Overlay	1250
None – Rewritable	Supported

Printer Components: Blank Cards

Type	Description
Card Size	The Card Printer accepts standard CR-80 and CR-79 sized cards.
Card Surface	<p>Suitable cards must have a polished PVC surface free of fingerprints, dust or any other types of embedded contaminants. In addition, cards must have a completely smooth, level surface in order for the Printer to achieve consistent color coverage.</p> <ul style="list-style-type: none"> • Certain types of Proximity cards have an uneven surface that will inhibit consistent color transfer. • Certain types of smart card chips are raised slightly above the cards surface which also results in poor color transfer.
UltraCard™ Brand Cards	<p>The UltraCard product line, available exclusively as part of HID's Global's brand secure card issuance solutions, has a long standing reputation among dealers and end-users for consistent quality in construction.</p> <ul style="list-style-type: none"> • In addition to blank stock, the UltraCard line is available in a variety of configurations for magnetic stripe, custom holograms and other additional anti-counterfeiting features. • UltraCard™ Premium is the preferred card for Direct-to-Card (DTC®) applications that require a higher quality card. The UltraCard Premium's composite material construction provides for maximum durability, flexibility and card life, with optimal resolution print quality for lamination and fluorescent panel Ribbon printing applications. • UltraCard™ PVC cards are medium-durability cards for a glossy, photo quality finish. These cards are manufactured to ensure clean, scratch-free cards for high-quality prints and extended Printhead life.

Section 2: Setup and Installation Procedures

This section describes the setup and installation for the DTC4500 Card Printers.

Choosing a Good Location

Follow these guidelines:

- Place the unit in a location with adequate air circulation to prevent internal heat build up.
- Use the Printer's dimensions as a guideline for the minimum clearances to the unit. (**Note:** Allow for adequate clearance in front of the unit to accommodate the unit with its Covers open.)
- Do not install unit near heat sources such as radiators or air ducts or in a place subject to direct sunlight, excessive dust, mechanical vibration or shock.

About Moisture Condensation

If the unit is brought directly from a cold to a warm location or is placed in a very damp room, moisture may condense inside the unit. Should this occur, print quality may not be optimum.

Leave the unit unplugged in a warm, dry room for several hours before using. This will allow the moisture to evaporate.



Caution: For safety purposes, Ethernet is not intended for a direct connection outside of the building.

Unpacking and Inspection

While unpacking your Printer, inspect the carton to ensure that no damage has occurred during shipping. Make sure that all supplied accessories are included with your unit.

Check that the following items are included:

- Power Supply
- US / EU Power Cable
- USB cable (2.0)
- Software Installation CD
- User Guide
- Warranty Statement, Compliancy Document

Installing the Print Ribbon Cartridge (DTC4500)

Fargo Card Printers require highly specialized supplies to function properly.

- The Fargo DTC4500 Card Printer uses a refill system.
- To maximize Printer life, reliability, printed card quality and durability, you must use only Fargo-certified supplies.
- For this reason, your Fargo warranty is void, where not prohibited by law, if you use non-Fargo-certified supplies.
- Printer cleaning is recommended with each Ribbon change to ensure quality printed cards.
- Resin-only Print Ribbons consist of a continuous roll of a single resin color. No protective overlay panel (O) is provided since resin images do not require the protection of such an overlay.

Installing the Ribbon

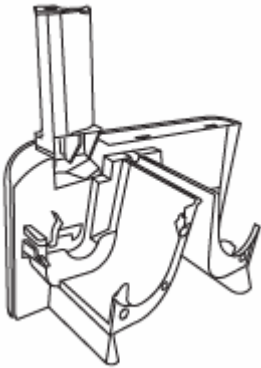
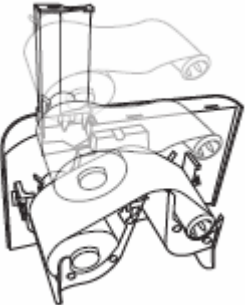
Step	Procedure
1	Lift up the Cleaning Roller Cover. 
2	Load the Print Ribbon into the Ribbon Drawer. 

Installing the Ribbon

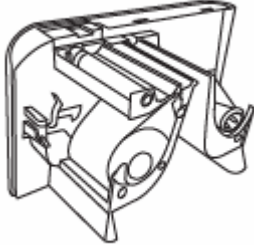
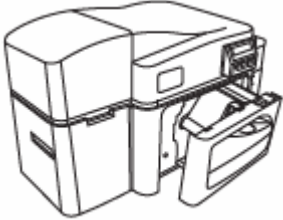
Step	Procedure
3	<p>a. Close the Cleaning Roller Cover.</p> <p>b. Insert the new Cleaning roller.</p>  <p>c. Remove the Cleaning Roller liner.</p>
4	<p>Load the Ribbon Drawer into the Printer.</p> 

Installing Blank Cards into the Card Hopper (DTC4500)

Using the Dual Hopper

Step	Procedure
1	<p data-bbox="266 537 483 569">Pre-instruction.</p> <div data-bbox="266 600 370 688"> </div> <p data-bbox="386 663 1203 730">Caution: Do not run the cards with a contaminated, dull or uneven surface through the Printer</p> <ul data-bbox="266 764 1284 1482" style="list-style-type: none"> • Printing onto such cards will ultimately lead to poor print quality and will greatly reduce the life of the Printhead. Card Types include PVC or PVC finish. • Cards eject into the Output Hopper or Reject Hopper. • Each Hopper holds 100 cards. • The DTC4500 is available with two (2) Hopper configurations: IN/OUT Hopper and Dual Hopper • Certain types of smart card chips are raised slightly above the cards surface which may result in poor color transfer. Design the card with white space surrounding the chip. (Note: The Fargo DTC4500 Printer is capable of printing single load cards and multiple feed cards (batch mode).) • To print using single feed, simply remove all cards from the Card Hopper, leave the Card Hopper door closed and place a card in the single Feed Card Slot (which can be used repeatedly). • Again, the cards should be loaded with the print side down and (if applicable) the magnetic strip up and towards the front of the Printer.

Using the Dual Hopper

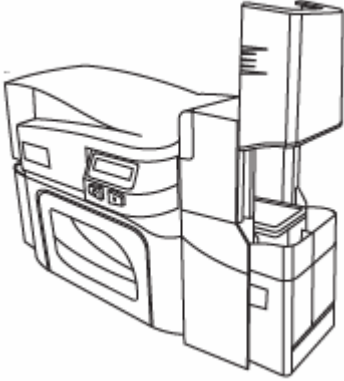
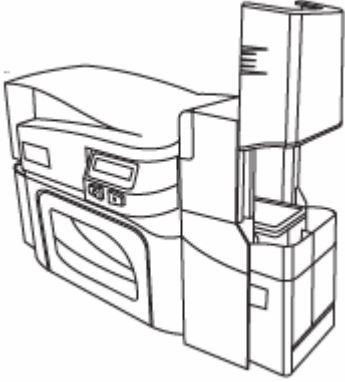
Step	Procedure
2	<p data-bbox="266 365 656 399">Open the Card Hopper Cover.</p>  <p>The diagram shows the DTC4500 Card Printer/Encoder from a three-quarter perspective. The Card Hopper Cover is shown in an open position, tilted upwards. The cover is a rectangular box that fits over the top of the card tray. The printer's main body is visible below the cover, showing the card tray and the printer's front panel.</p>
3	<p data-bbox="266 911 1263 945">Press the Card Hopper Load Lever down until the Card Tray locks into place.</p>  <p>The diagram shows the DTC4500 Card Printer/Encoder from a three-quarter perspective. The Card Hopper Load Lever is shown in a closed position, pressed down. The lever is a small, rectangular component located on the side of the Card Hopper Cover. The cover is now closed and flush with the printer's body.</p>

Using the Dual Hopper

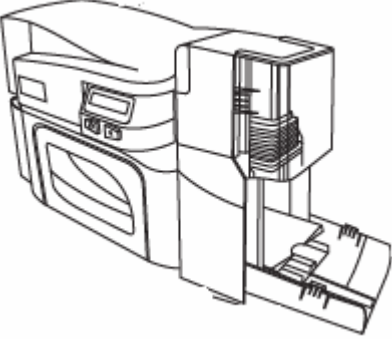
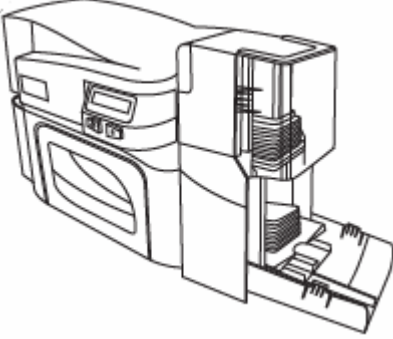
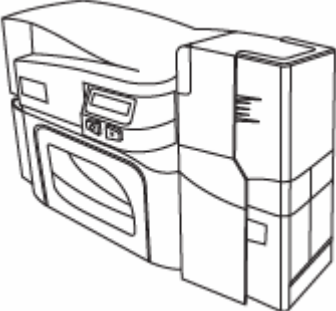
Step	Procedure
4	<p>Load up to 100 cards into the Hopper with the print side down. (Note: If using cards with a magnetic stripe, the magnetic stripe should be loaded with the stripe up and to the front of the Printer.)</p> <p>Display: Card loaded into the upper Hopper of DTC4500 Dual Hopper</p>  <p>Display: Cards loaded into lower Hopper of DTC4500 Dual Hopper</p> 
5	<p>Close the Card Hopper Cover to release the lever to the printing position.</p> 

Setting the Card Size for CR79 and CR80

Follow this procedure in the Printer and in the Printer Driver to setup the card size.

Step	Procedure
1	<p>Remove the Ribbon Drawer and locate the slide bar</p> 

Setting the Card Size for CR79 and CR80

Step	Procedure
2	<p>If using the CR79 card, push the slide bar to the LEFT.</p>  <p>Push LEFT for CR79 card size</p>

Setting the Card Size for CR79 and CR80

Step	Procedure
3	<p>If using the CR80 card, push the slide bar to the RIGHT.</p>  <p>Push RIGHT for CR80 card size</p>

Setting the Card Size for CR79 and CR80

Step	Procedure
4	From the Driver Printing Preferences, select the correct card size.

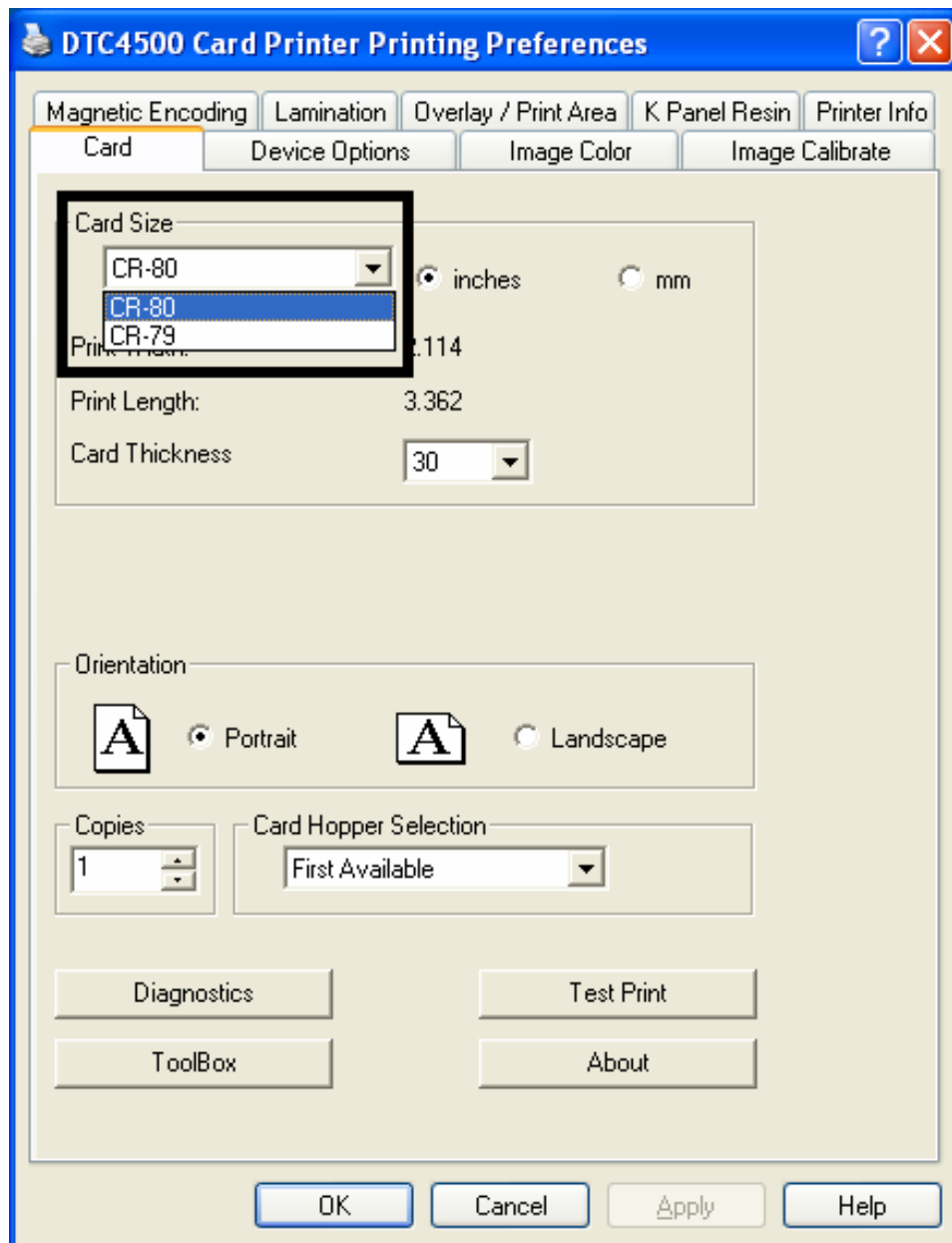

Connecting the Printer power

Follow this procedure. (**Note:** Do not connect the Printer's USB cable until prompted during the Printer Driver installation.)

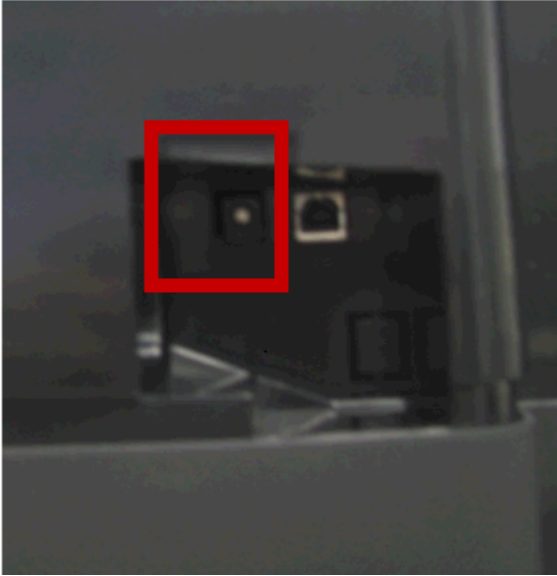
Step	Procedure
1	<p>Plug the AC adapter power cable into the back of the Printer.</p>  A photograph showing the back panel of a printer. A red square highlights a circular AC power jack. To the right of the jack is a square port, likely for a USB connection. The printer is dark-colored, and the background is slightly blurred.
2	<p>Plug the wall power cable into the AC power adapter. Plug the wall power cable into a standard 100-240 VAC power outlet.</p>

Connecting the Printer power

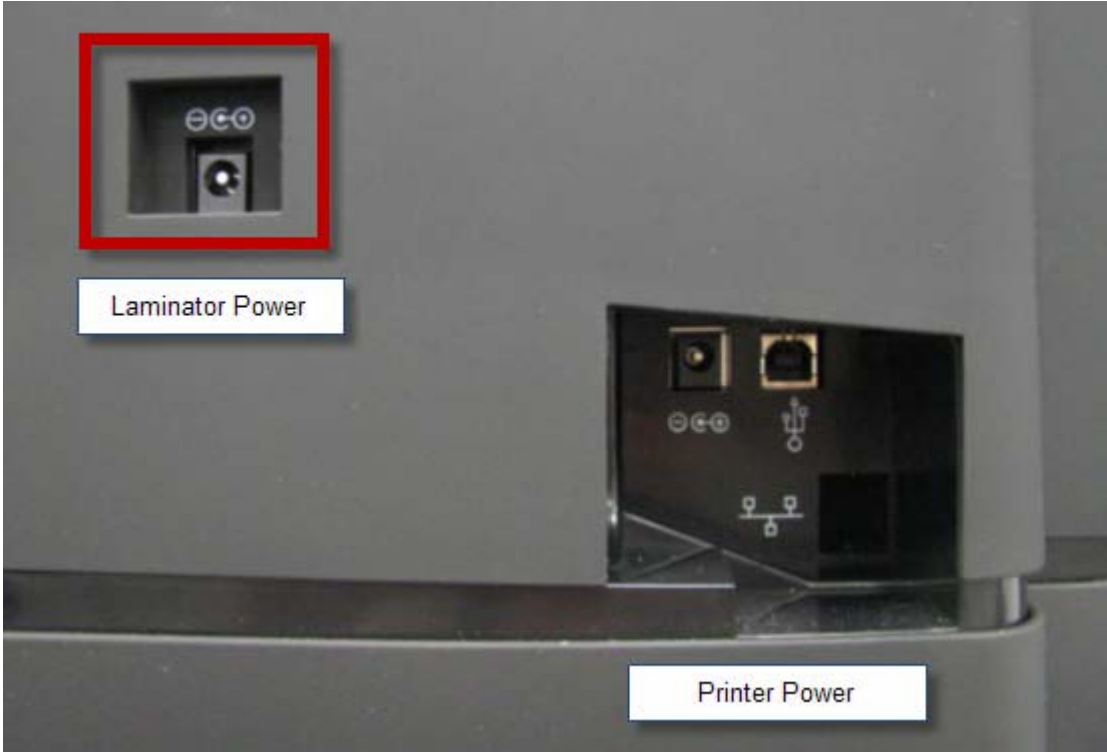
Step	Procedure
3	<p>DTC4500 with Laminator:</p> <p>Plug the wall power cable into the AC power adapter.</p> <p>Plug the wall power cable into a standard 100-240 VAC power outlet.</p>  <p>The image shows the back of the printer with two power ports. The 'Laminator Power' port is a square AC inlet, highlighted with a red square. The 'Printer Power' port is a standard AC power jack. Both ports are labeled with white boxes below them. The printer's body is dark grey.</p>

Section 3: Print Driver Installation

This section describes the Printer Driver installation requirements and standard procedures. Requirements are listed below. The DTC4500 Print Driver supports the following:

- Windows Vista 32 bit w/SP2
- Windows Vista 64 bit w/SP2
- Windows XP 32 bit w/SP3
- Windows Server 2003 (R1) 32 bit
- Windows Server 2008 (R1) 32 bit w/SP2
- Windows Server 2008 (R1) 64 bit w/SP2
- Windows Server 2008 R2
- Windows 7 32 and 64 bit
- Linux OS (Ubuntu7.10, Red Hat Enterprise Desktop 5, Fedora Core 7 & 8, openSUSE 10.3 , open NOVELL SUSE 10.). Contact HID/Fargo Technical Support for the driver.

For more information in supported operating systems, please visit: www.hidglobal.com

Driver Installation Instructions



CHOOSE LANGUAGE

VIEW THE PRINTER QUICK START GUIDE

INSTALL THE PRINTER DRIVER

INSTALL THE FARGO WORKBENCH

Contact FARGO Support

fargo.hidglobal.com

HID

FARGO® DTC4500
Direct-to-Card Printer

Driver Installation Instructions

Start the installation process by inserting the Driver CD into the computer. Then, follow the Installaware Wizard screen prompts.

- Select **Install the Printer Driver** to start the installation.
- Select the Fargo Workbench Utility Program to install this program.
- Select the Swift ID™ (Embedded Badging Application software) to install this program.
- All versions of Windows require Administrator rights.
- From the Printer & Faxes folder, open the Printing Preferences to setup the Driver after it has been installed.
- Printing Preferences need to be setup after the Driver has been installed. Each TAB is shown in the next section.
- Use the drop down arrows to select the correct options for each printing preference.
- **Enable Swift ID over a USB connection:** This item will be checked if the printer is setup to utilize Swift ID via a USB connection. When this box is checked the Ethernet connection (if applicable) on the printer will not be operational. If this selection is not be accessible, this is because the HID EEM driver that Swift ID uses to connect via a USB connection has not been installed. This driver can be found on the installation CD or it can be down loaded from the HID Global support page. The easiest method for enabling Swift ID is to un-install the printer and its components and go through the installation procedure and select that you would like to use the Swift ID application.

Swift ID Installation Instructions

Here are the related definitions for the Swift ID installation instructions.

- **Swift ID:** This is a 'built-in badging' application which enables Users to create simple ID badges without having to install any additional software. (**Note:** This application is only intended for use between one Printer and one PC. The application cannot select between Printers; also, only one Printer on a PC can access Swift ID.)
- **HID EEM Driver:** This Driver is used by Swift ID to communicate with the PC when connected via a USB cable. (**Note:** It is also known as an 'Ethernet Emulation Module'.)
- **EEM Device Flag (i.e., Enable Swift ID over a USB connection):** Check this item to utilize Swift ID via a USB connection. (**Note:** When this box is checked, the Ethernet connection (if applicable) on the Printer will not be operational.)
 - If this flag or selection is not accessible, it means the HID EEM Driver (that Swift ID uses to connect via a USB connection) has not been installed. (**Note:** This Driver can be found on the installation CD or it can be downloaded from the HID Global support page.)

Swift ID Installation Instructions (continued)

- **Enabling Swift ID:** The easiest method for enabling Swift ID is to (a) un-install the Printer Driver and its components, (b) complete the designated installation procedure, and (c) select the desired connection type for the Swift ID application: USB or ETHERNET.

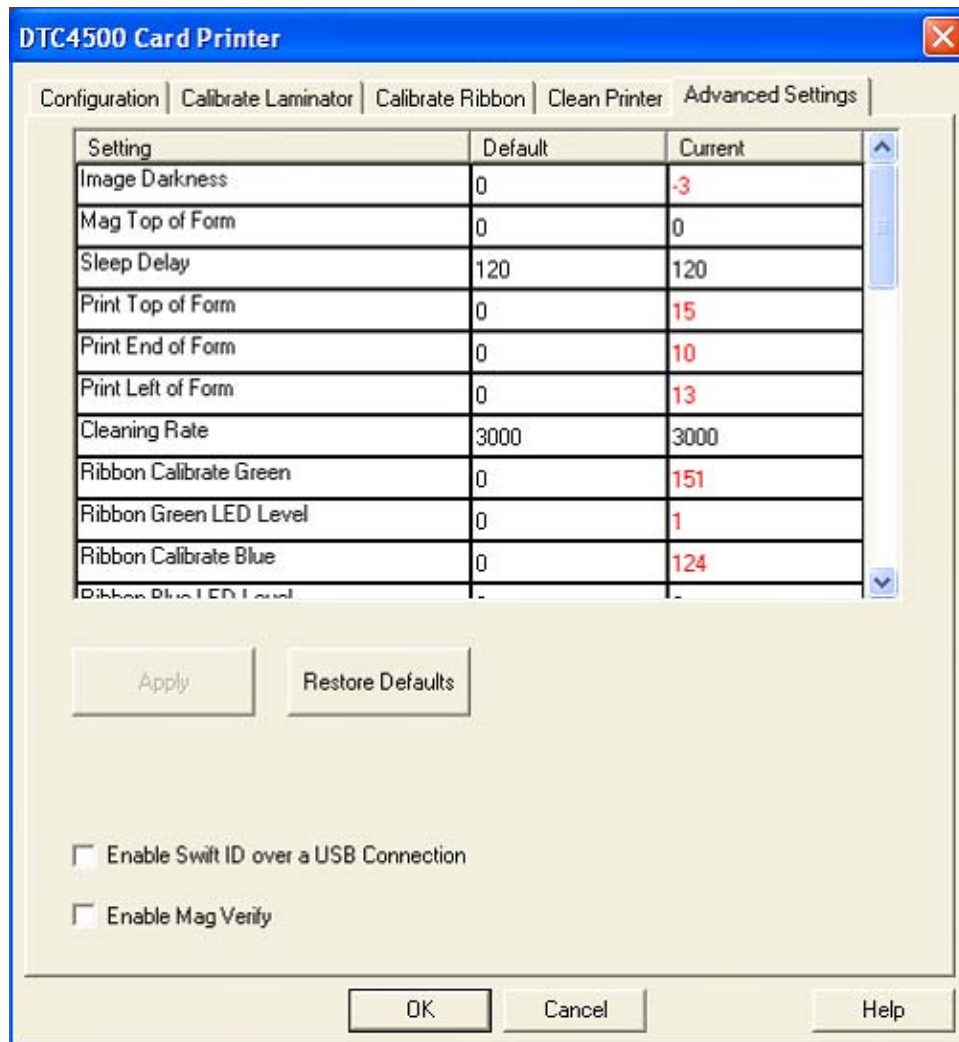

Installing Swift ID



Printer Installed On Network

Perform this procedure for a Printer installed on a Network.

Step	Procedure
1	Connect the Printer to the Network.
2	<p>Find the IP Address on a DTC4500.</p> <p>a. Navigate through the Printer display to reach the IP address.</p>  <p>The screenshot shows the following settings:</p> <pre> User Printer Settings Model: DTC1000 Serial Number: 00000005 FW Rev: 0.0.6.2 Feb 5 2010 IP Address: 10.244.69.70 MAC Address: 00:13:44:00:03:05 Image Darkness: 1 Print Top Of Form: 12 Print End Of Form: 10 Print Left Of Form: 16 Mag Top Of Form: 0 Mag End Of Form: 0 Ribbon Print Tension: -5 Resin Heat Adj: 10 Erase Heat Offset: 0 Write Heat Offset: 0 Head Resistance: 2770 Head Home Offset: 200 Head Contact Offset: 103 Display Contrast: 170 Sleep Delay: 120 min Cleaning Rate: 3000 cards Cards Since Cleaned: 186 Total Card Count: 186 </pre>
3	<p>a. Open up a Web Browser.</p> <p>b. Type the IP Address followed by /SwiftID.html to access the Swift ID badging application.</p> <ul style="list-style-type: none"> • For example: 10.244.69.70/SwiftID.html
4	You should see this page by using the Browser.



Printer Connected Via USB Connection

Perform this procedure when attempting to use Swift ID on the initial setup of a Printer connected via a USB connection. (**Note:** This application is not intended for use with multiple printers.)

- To start using Swift ID via a USB connection with a DTC1000, DTC4000, or a DTC4500 that has already been installed on the PC, please choose Option No. 1 or No. 2 and complete the procedure.

Step	Procedure
1	<p>Follow the on-screen instructions during the Printer Driver installation process to install all the necessary components (in order to access Swift ID via a USB connection). (Note: The HID EEM Driver will be installed. A shortcut will be installed on the desktop, which allows you to easily launch the application. See below.)</p> 

Option No. 1

Step	Procedure
1	Uninstall the Printer Driver and go through the installation process again and check the box to use Swift ID

Option No. 2

Step	Procedure
1	Run the HID EEM Driver install from the Driver CD or download the HID EEM Driver install from the support page
2	Run the installation file
3	Once the Driver has been installed, enable the Enable Swift ID over a USB Connection flag in the advanced section of the Printer Driver. (Note: When this flag is checked, a new Printer instance will appear and the old Printer instance will no longer be valid.)

Uninstalling Swift ID

Please follow these instructions:

- **For a printer installed on a Network:** There are no steps needed to remove any of the components of Swift ID.
- **For a printer that is connected via a USB connection:** Disable the **Enable Swift ID over a USB Connection** flag in the advanced section of the Printer Driver and then 'run' the uninstall HID EEM Driver setup. (**Note:** When this flag is disabled, a new Printer instance will appear and the old Printer instance will no longer be valid.)

Additional Swift ID Rules

The following happens when (a) the HID EEM Driver for Swift ID has been installed on the PC for a Printer and (b) a second Printer with the EEM flag turned on is connected to the PC:

- A Printer instance will appear for the second Printer; however, a second shortcut for Swift ID will not appear. (**Note:** Swift ID is not intended to operate with two Printers.)
- If both Printers are connected to the PC, the Printer (that is first turned on) will be tied into Swift ID.

The following happens when (a) the EEM Driver has not been installed on the PC and (b) another Printer (same model) with the EEM flag turned off is connected to the PC. (**Note:** The Swift ID User Guide is located within the application.)

- A Printer Driver instance will appear.
- The User will not be asked to turn on the flag in the Printer.
- The HID EEM Driver will not be installed on the PC.
- The EEM flag in the Printer Driver will be 'greyed out'; so that the User cannot alter this state.

Section 4: Printer Preferences Tab Functions

This section provides an overview of the Printer Driver preferences tab.

Using the Card tab

Click on the Card tab to bring up the window (shown below). Refer to the **Help** file for the **Fargo Workbench Utility Program and User Guide**.

The screenshot shows the 'DTC4500 Card Printer Printing Preferences' window with the 'Card' tab selected. The window has several tabs: 'Magnetic Encoding', 'Lamination', 'Overlay / Print Area', 'K Panel', 'Card', 'Device Options', and 'Image Color'. The 'Card' tab is active and contains the following settings:

- Card Size:** A dropdown menu set to 'CR-80', with radio buttons for 'inches' (selected) and 'mm'.
- Print Width:** 2.114
- Print Length:** 3.362
- Card Thickness:** A dropdown menu set to '30'.
- Orientation:** Radio buttons for 'Portrait' (selected) and 'Landscape'.
- Copies:** A spinner box set to '1'.
- Card Hopper Selection:** A dropdown menu set to 'First Available'.
- Buttons:** 'Diagnostics', 'Test Print', 'ToolBox', and 'About'.

Red lines connect callout boxes to these specific settings. The callouts provide the following instructions:

- Card Size:** Select either **CR-80 (ISO ID-1)** or **CR-79** sized cards for Card Size.
- Units:** Click **inches** or **mm** to choose the desired unit of measurement.
- Dimensions:** Select Print **Print Width** or **Print Length** for the desired Card Dimensions.
- Thickness:** Select **Card Thickness (mil)** as required for that dimension.
- Orientation:** Select **Portrait** for vertical orientation and **Landscape** for horizontal orientation.
- Copies:** Select the number of copies.
- Hopper:** Select the correct Card Hopper.
- Diagnostics:** Click on **Diagnostics** to bring up the Workbench Printer Utility.
- Test Print:** Click on the **Test Print** button to send a self-test print to the Printer.
- About:** Click on the **About** button to bring up the Copyright, Version, and Date Code information for Printer Driver Software.

Additional callouts at the bottom of the window:

- ToolBox:** Click on the **Toolbox** button to bring up the Configuration, Calibrate Ribbon, Clean Printer, and Advanced Settings.
- Note:** See below for more information on the Diagnostics and Toolbox.

Using the Toolbox Options

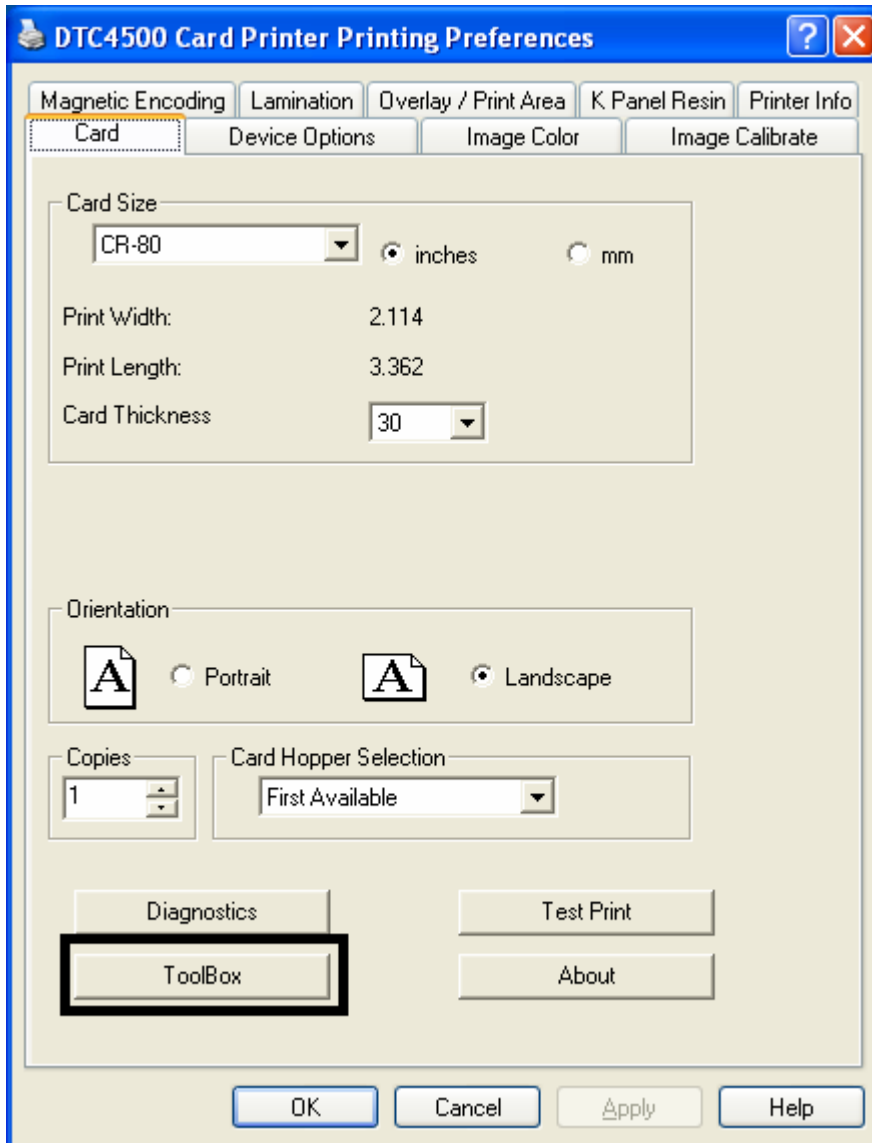

Using the Configuration Tab

This option is used to show the currently installed Optional Printer features, Event Monitoring, to set the Printer Driver language and Printer LCD Display language.

- To switch between languages, select the desired language and select OK twice, then reopen the driver in the new language

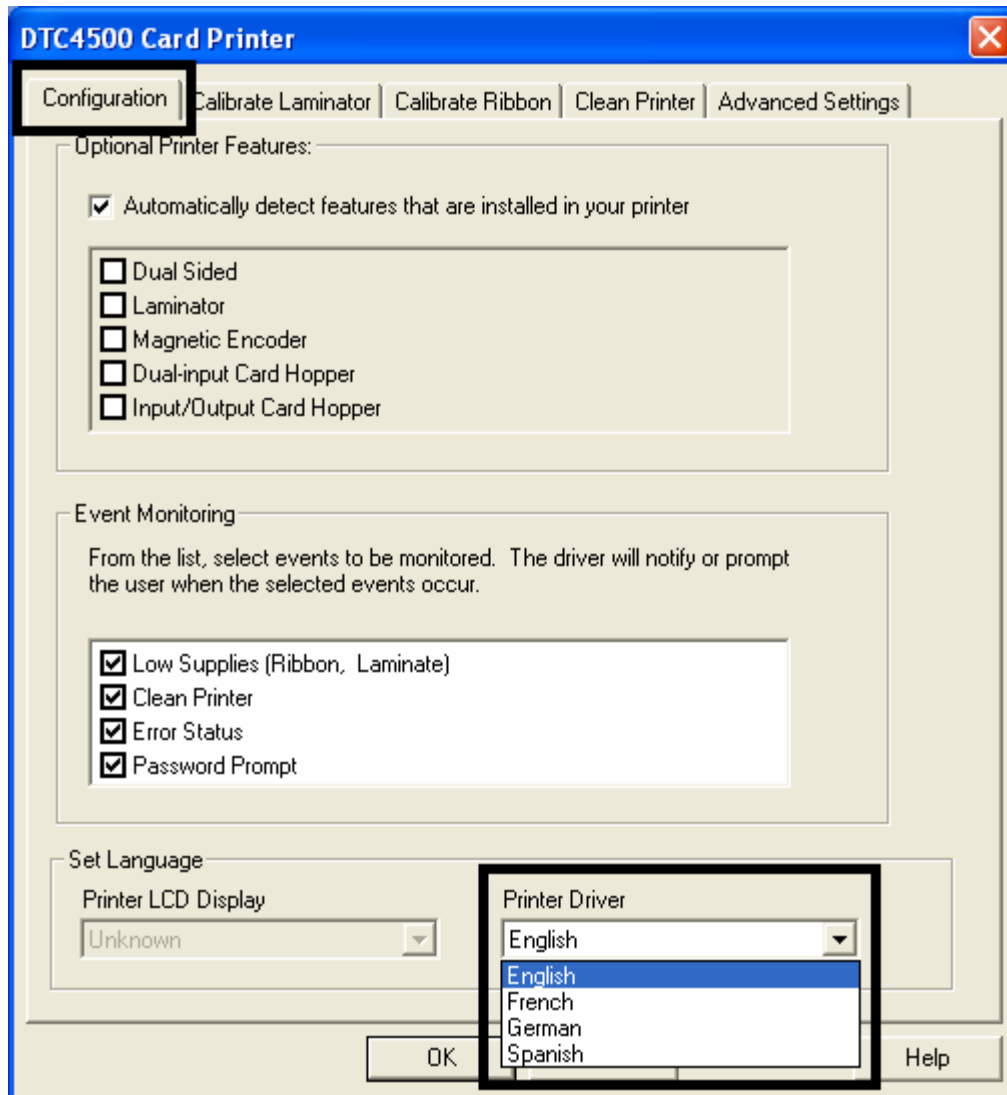

Using the Event Monitoring Group Box

This Event Monitoring group box displays the Low Supplies (Ribbon, Laminate and Film).

- **The default setting is checked.** If checked, the Ribbon Low message box is displayed with every print job when Printer reports low Ribbon to the Driver.

Selecting the Calibrate Laminator tab

The Calibrate Laminator tab is active when the Laminator is automatically detected or when the Laminator is manually checked (as a Printer Feature on the Configuration tab). If the Laminator is not detected and not manually checked, the tab is active; however, all functions are grayed out.

- **Calibrate button:** Sends calibrate Laminator command to Printer. Follow the instruction on the page for setting up the Printer.
- **Help button:** Launches help specific to this tab.

Step	Procedure
1	<p>Select the Calibrate Laminator tab.</p> <ol style="list-style-type: none"> Ensure that the Cartridges are out of the Laminator. Ensure the Laminator Cover is closed. Click on the Calibrate button. (Note: The Printer's LCD will display CALIBRATE PASSED. Click on the OK button on the LCD display to complete the procedure.

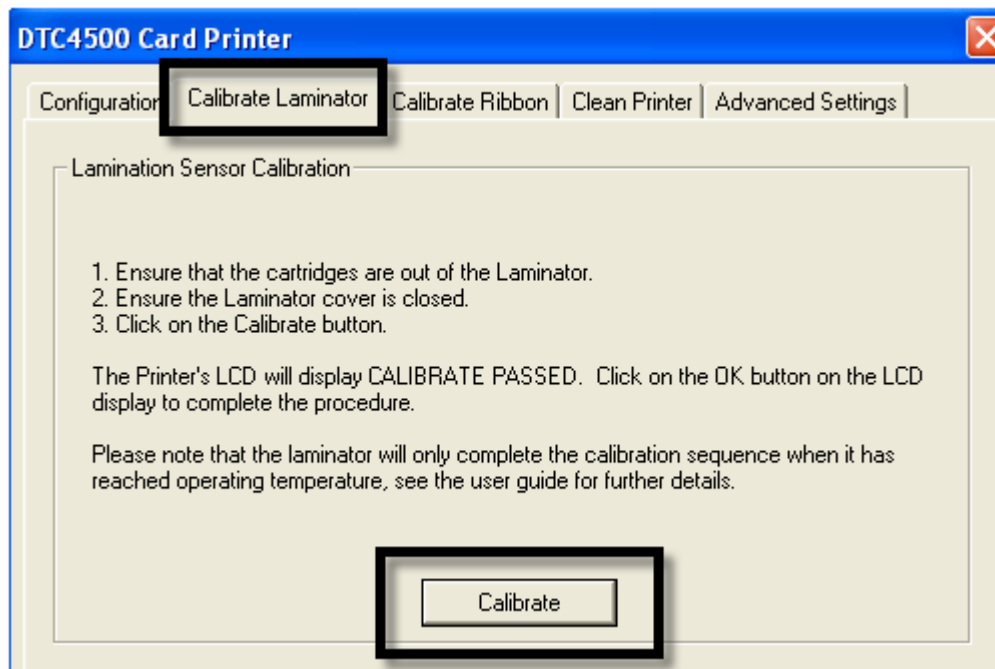

Selecting the Calibrate Ribbon tab

The two buttons for the Calibrate Ribbon tab are described below.

- **Calibrate button:** Sends the Calibrate Ribbon Command to Printer. Follow the instructions below to set up the Printer.

Step	Procedure
1	<p>Select the Calibrate Ribbon tab.</p> <ol style="list-style-type: none"> Ensure that the Ribbon is removed from the Ribbon Drawer. Ensure the Printer's Ribbon Drawer is closed. Ensure the Printer's Cover is closed. Click on the Calibrate button. (Note: The Printer's LCD will display CALIBRATE PASSED.) Click on the OK button (on the driver window) to complete the procedure.

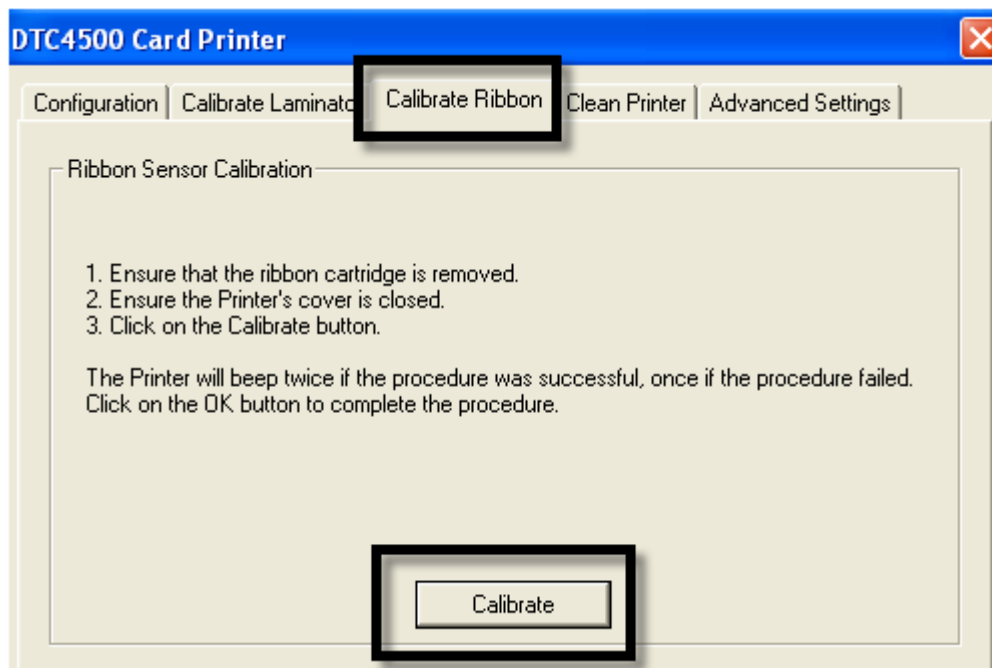

Selecting the Clean Printer tab

The button for the Clean Printer tab is described below.

- **Clean Button:** Launches cleaning routine. Follow the instruction on the page for setting up the Printer.
- **Help button:** Launches help that is specific to this tab.
- Also see [Cleaning the Printer](#) for full instructions.

Selecting the Clean Printer tab

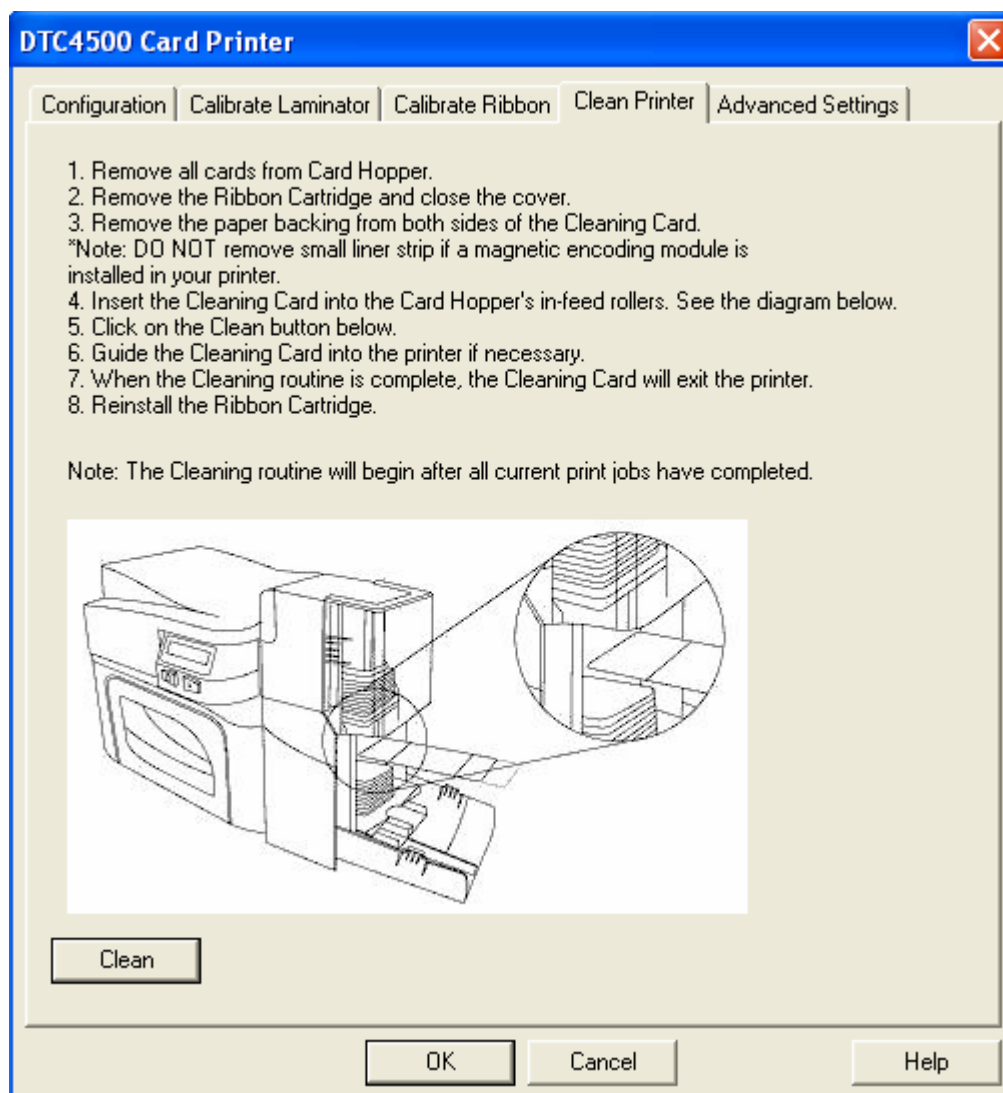

Selecting the Advanced Settings tab

Use the **Advanced Settings** tab for adjusting the internal Printer settings, which are customized for every Printer at the factory and saved directly within the Printer's memory. (**Note:** You can select the Restore Defaults to restore the internal default settings.)

Selecting the Advanced Settings tab

These change values for Firmware settings. See below.

- **Setting Column:** Displays label for setting
- **Default Column:** Displays default value for setting
- **Current Column:** Displays current value for setting
 - Change the value by clicking on the value to activate spin control or type.
- **Apply Button:** Applies changed values.
- **Restore Defaults Button:** Restores default values.

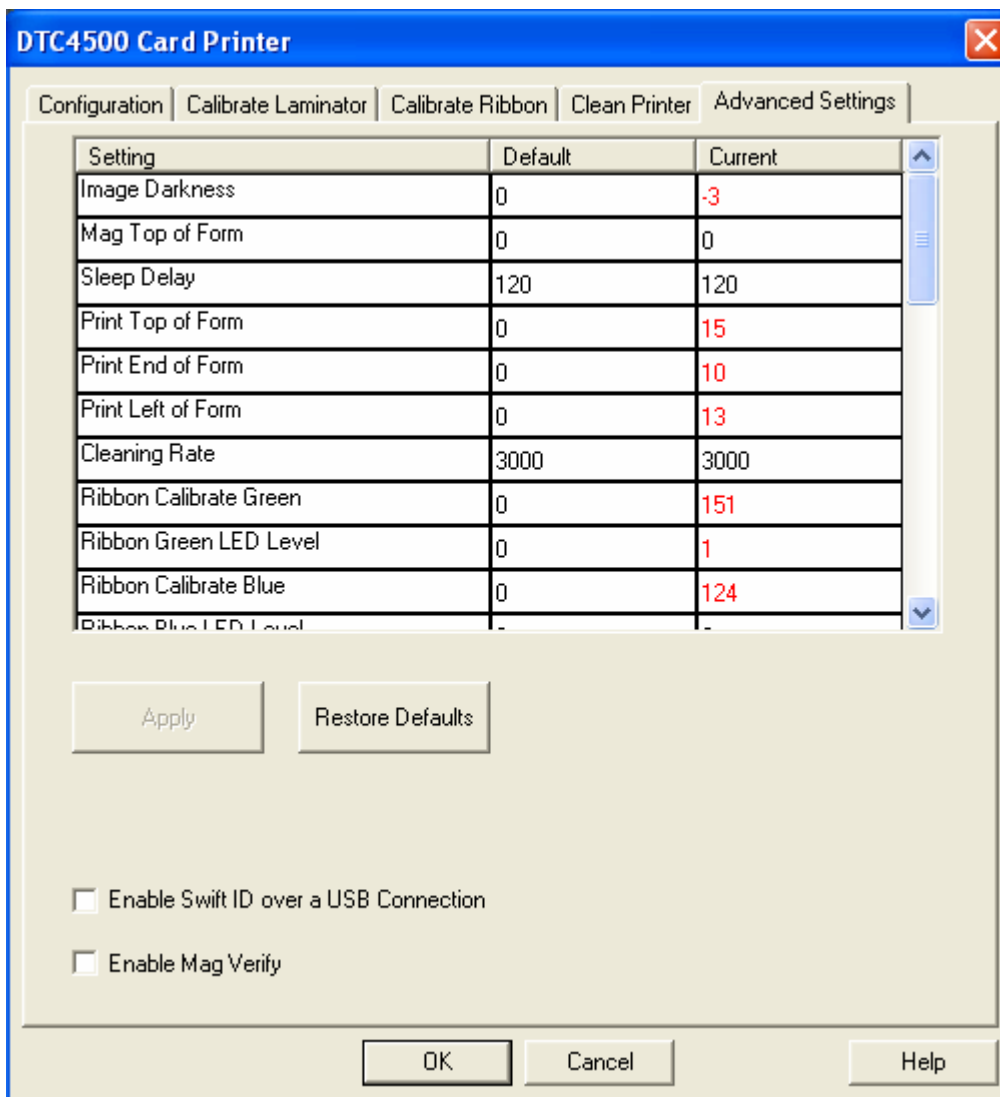

Selecting the Advanced Settings tab



Example:

Setting	Default	Current
Image Darkness	0	-14

Selecting the Advanced Settings tab

Setting	Option
Image Darkness	<p>Use this option to set the overall darkness of the printed image by increasing or decreasing the amount of heat (used by the Printhead when printing).</p>  <p>Caution: If the value is set too high, the Ribbon may jam or even break.</p>
Mag Top of Form	<p>Use this option to shift the starting point where the Printer begins to encode the magnetic track data on the card's Magnetic Stripe.</p>  <p>Caution: If the negative value is set too high, the Printer may start encoding before the Magnetic Stripe reaches the encoding head.</p> <ul style="list-style-type: none"> • Maximum adjustment range is +/- 80. • Each increment equals .01".
Sleep Delay	<p>The Sleep Time setting adjusts the number of minutes of inactivity before the Printer enters a low power sleep state.</p>

Selecting the Advanced Settings tab

Setting	Option
Print Top of Form	<p>Use this option to adjust the length-wise or horizontal position of the printed image on the card (so it appears to be centered).</p>  <p>Caution: If the negative value is set too high, the Print Ribbon may break.</p>
Print End of Form	<p>Use this option to reduce or increase the overall printable area; this is done in order to optimize edge to edge printing toward the trailing edge of the card.</p> <ul style="list-style-type: none"> • Maximum adjustment range is +/- 127. • Each increment equals .01”.
Print Left of Form	<p>Use this option to adjust the vertical position of the printed image on the card; so it appears centered.</p> <ul style="list-style-type: none"> • Maximum Adjustment Range is +/- 127. • Each increment equals .01”.
Cleaning Rate	<p>Use this option to adjust the number of cards printed before the Printer displays a message indicating cleaning is needed.</p> <ul style="list-style-type: none"> • The default value is 3000 cards.

Selecting the Advanced Settings tab

Setting	Option
Ribbon Calibrate Green	This is a calibration driven value and should not be adjusted. (Note: This is factory set and should not be changed unless directed by a technician.)
Ribbon Green LED Level	This is a calibration driven value and should not be adjusted. (Note: This is factory set and should not be changed unless directed by a technician.)
Ribbon Calibrate Blue	This is a calibration driven value and should not be adjusted. (Note: This is factory set and should not be changed unless directed by a technician.)
Ribbon Blue LED Level	This is a calibration driven value and should not be adjusted. (Note: This is factory set and should not be changed unless directed by a technician.)
Ribbon Print Tension	Use the Ribbon Tension option to increase or decreases the amount of tension (drag) on the Ribbon during printing.
Flipper Home Offset	This is a calibration driven value and should not be adjusted. If the Flipper unit is replaced and has not been calibrated, this value may need to be adjusted. (Note: This is factory set and should not be changed unless directed by a technician.)

Selecting the Advanced Settings tab

Setting	Option
Flipper Lam Height Offset	This is a calibration driven value and should not be adjusted. If the Flipper unit is replaced and has not been calibrated, this value may need to be adjusted. (Note: This is factory set and should not be changed unless directed by a technician.)
Mag HI-Co Voltage Offset	This option changes the voltage going the magnetic head. (Note: This is factory set and should not be changed unless directed by a technician.)
Mag Lo-Co Voltage Offset	This option changes the voltage going the magnetic head. (Note: This is factory set and should not be changed unless directed by a technician.)
OLED Contrast (display contrast)	Use this option to increase or decrease the contrast of the printer OLED (if applicable).
Resin Heat Adjust	Use this adjustment for Black resin text and barcodes if they appear faded or too light/dark. <ul style="list-style-type: none"> Maximum Adjustment Range is +/- 100. (Note: This control can be helpful for fine-tuning the transfer of resin text and bar codes.)
Head Resistance	This is factory set. If the main board or the Printhead is replaced then adjust this number. Locate the Printhead Setting Number on the bottom of the Printhead. The number reads R=XXXX.

Selecting the Advanced Settings tab

Setting	Option
Head Home Offset	<p>This is a calibration driven value and should not be adjusted. If the Printhead assembly is replaced then this value may need to be adjusted.</p> <p>(Note: This is factory set and should not be changed unless directed by a technician.)</p>
Head Contact Offset	<p>This is a calibration driven value and should not be adjusted. If the Printhead assembly is replaced then this value may need to be adjusted.</p> <p>(Note: This is factory set and should not be changed unless directed by a technician.)</p>
Erase Heat Offset	<p>Adjust the Erase temperature for the rewriteable cards as needed.</p> <ul style="list-style-type: none"> • Increase the Current Setting to cause more heat to be used in the erasing process. <p>OR</p> <ul style="list-style-type: none"> • Decrease the Current Setting to cause less heat to be used in the erasing process. <p>(Note: Erase Heat Offset provides user ability to control the Printhead heat level when the Erase Operation is performed)</p>

Selecting the Advanced Settings tab

Setting	Option
<p>Write Heat Offset</p>	<p>Adjust the Write temperature for the rewriteable cards as needed.</p> <ul style="list-style-type: none"> • Increase the Current Setting to cause more heat to be used in the printing process of a rewritable card. <p>OR</p> <ul style="list-style-type: none"> • Decrease the Current Setting to cause less heat to be used in the printing process of a rewritable card. <p>(Note: Write Heat Offset provides user ability to control the Printhead heat level when the Write Operation is performed. Appropriate heat levels should be applied for the proper writing process.)</p>
<p>Enable Swift ID over USB connection</p>	<p>Enable Swift ID over a USB connection - Check this item to utilize Swift ID via a USB connection. When this box is checked the Ethernet connection on the printer will not be operational.</p> <ul style="list-style-type: none"> • If the USB selection is not be accessible, the HID EEM driver that Swift ID uses to connect via a USB connection has not been installed. • This driver can be found on the installation CD or it can be downloaded from the HID Global support page. • The easiest method for enabling Swift ID is to un-install the printer driver and its components and go through the installation procedure. <p>Select the desired connection type for the Swift ID application: USB or Ethernet.</p>

Using the Device Options tab

Click on the Device Option tab to bring up the window (shown below).

• Click Detect Supplies at Print Time to verify that the Ribbon type selected matches the Ribbon installed in the Printer.

The Printer Driver will change the Ribbon type to the correct setting. The dialog indicates either the current setting has changed or the current Ribbon type is correct.

• Select this option to rotate the image on the card's front by 180 degrees (when printed).

• Select this option to rotate the image on the card's back by 180 degrees (when printed).

• Use this option to disable the printer's capabilities.

DTC4500 Card Printer Printing Preferences

Magnetic Encoding | Lamination | Overlay / Print Area | K Panel Resin | Printer Info

Card | **Device Options** | Image Color | Image Calibrate

Supplies

Automatically detect the installed Ribbon for every print job.

Ribbon Type:

YMCKO - Full Color/Resin Black/Overlay

Dual Sided

Print Both Sides

Split 1 Set of Ribbon Panels

Print Back Image on Front of Card

Print Back Side Only

Options

Rotate Front 180 Degrees

Rotate Back 180 Degrees

Disable Printing

Invert F-panel Image

Write Only

OK Cancel Apply Help

Using the Device Options tab

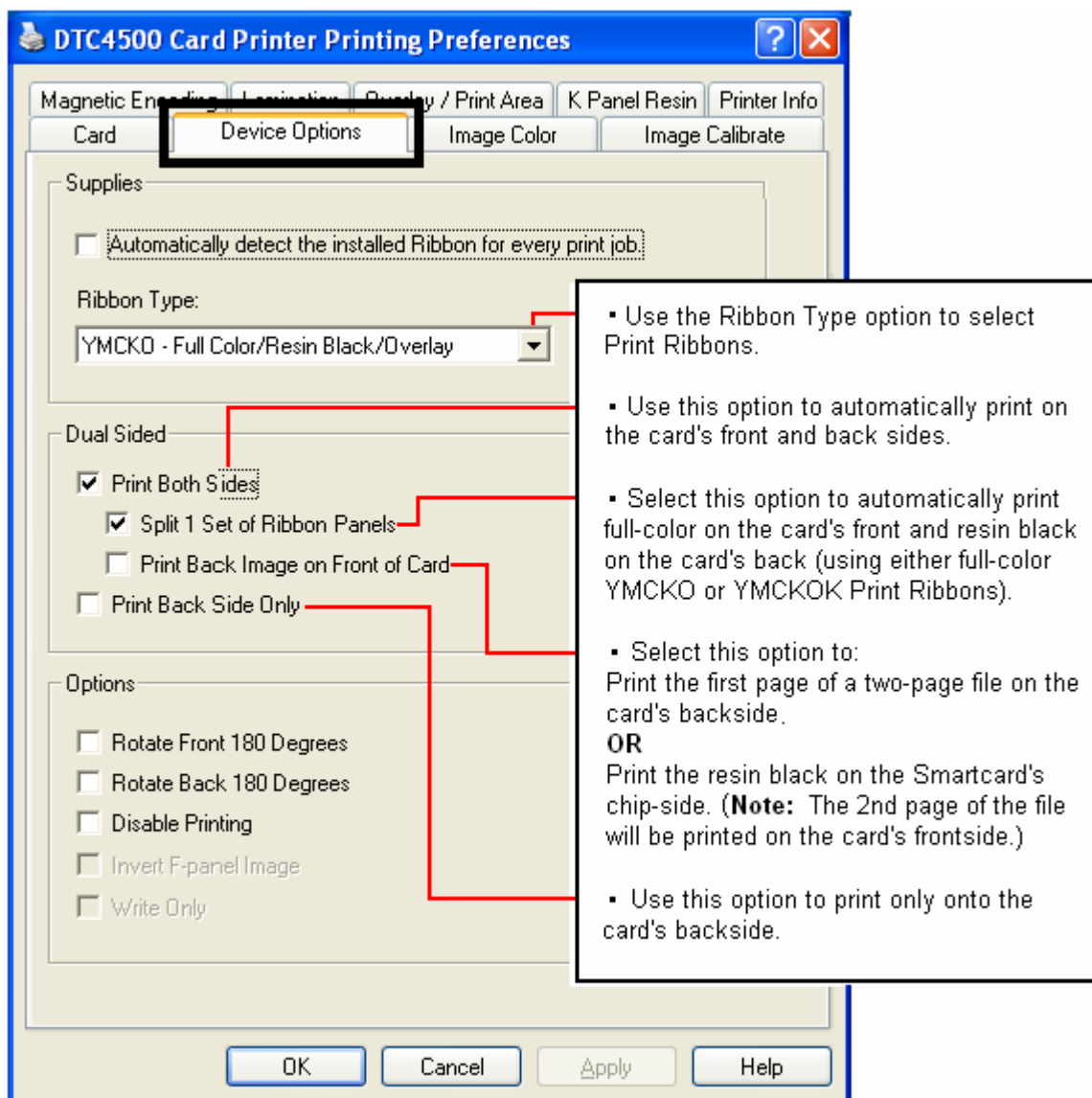

Using the Device Options tab

You can use this option for the re-writable cards. Select the **Write Only** option.

- The default setup is for the Printer to first erase the previously-printed card; then write the new information on the card.
- If you are printing to a new card, select **NONE - Re-Writable** to speed up the process. The full card is erased and printed. There is no option to select specific areas to erase.
- To print/erase a certain section, use the Overlay/Print Area tab in the Driver. Select the specific area in the same manner as the print job with the Color Ribbon.
- To erase many cards, use the **Fargo Workbench Re-Writable Card Eraser** option. This option does not print. It will only erase.

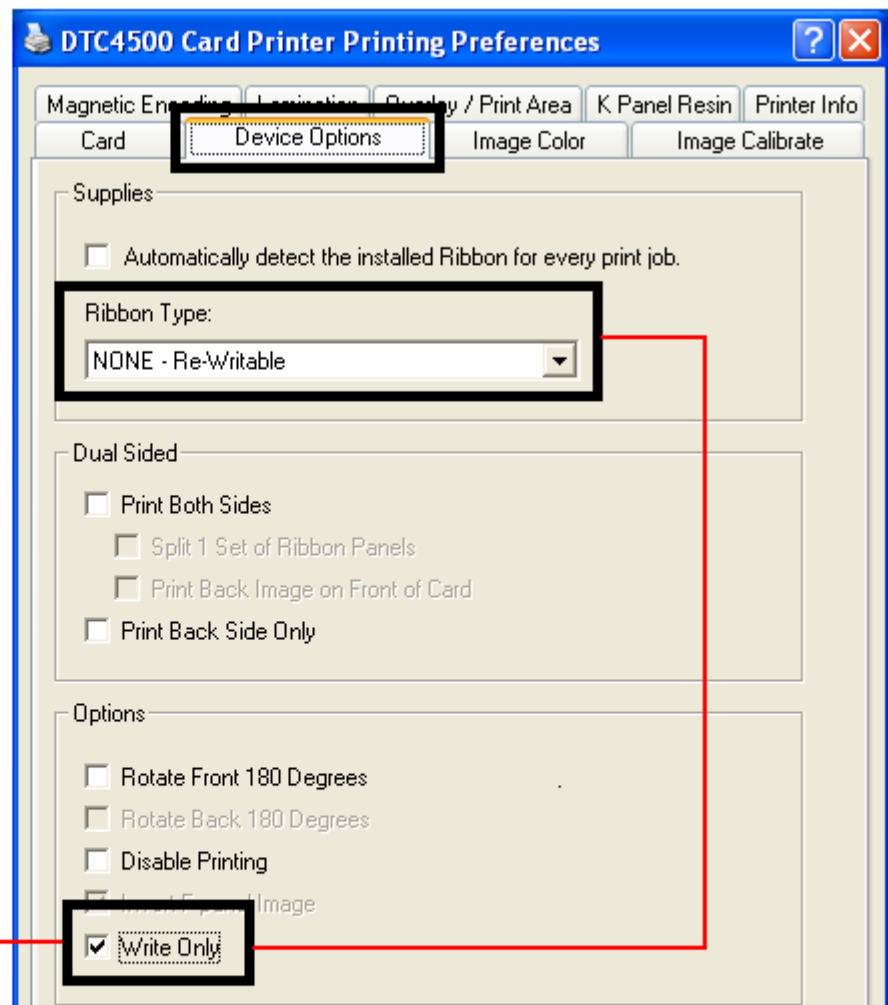

Caution: No Ribbon is used with these cards. Do not load a Ribbon into the Printer when using this process. Printing on the Re-Writable card with a Ribbon will ruin the card.

Using the Image Color tab

Click on the Image Color option tab to bring up the window (shown below).

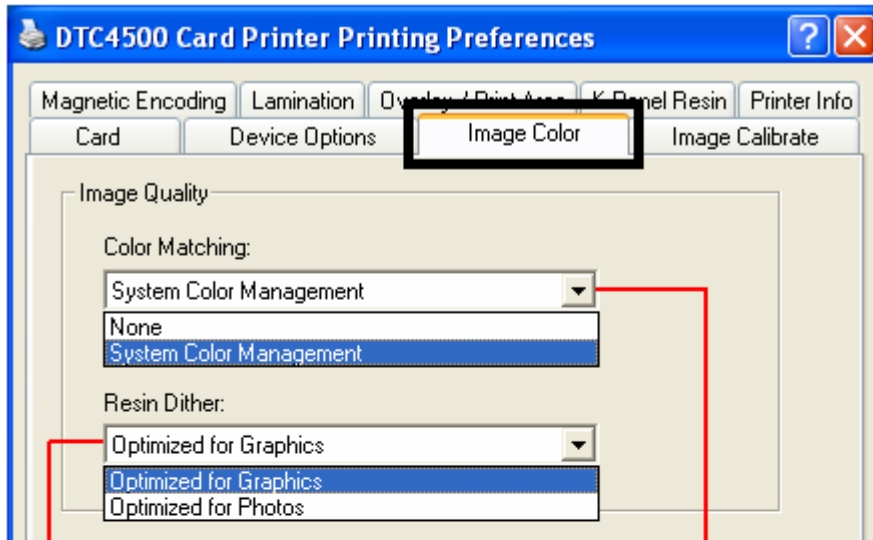

Select the appropriate dither method according to the type of image to be printed. This option affects objects printed with a resin-only Print. Select Optimized for Graphics when printing drawings and graphics (e.g., clipart, logos, etc.) with resin.
OR
Select Optimized for Photos when printing photo quality images with resin.

Use the Color Matching dropdown menu to choose the color matching options which best fits the print job requirements. Select None for print speed versus print color or for use of third party color matching software.
OR
Select System Color Management for Windows to make color corrections. This provides a closer match to the RGB color specifications.

Using the Image Color tab

Control the overall darkness and lightness of the printed image by adjusting the Dye-Sub Intensity slider.

- Move the slide to the left to cause less heat to be used in the printing process and to generate a lighter print.

OR

- Move the slide to the right to cause more heat to be used, thus generating a darker print. This slide only affects images printed with dye-sublimation Ribbon panels (YMC).

Use this option to control the amount of heat the Printer uses when printing with the resin black panel(s) of a full-color Ribbon or when printing with a resin-only Ribbon by adjusting the Resin Heat slide.

- Move the slide to the left to (a) cause less heat to be used in the printing process and (b) cause resin images to be lighter or less saturated.

OR

- Move the slide to the right to (a) cause more heat to be used or (b) cause the resin image to be darker or more saturated.

Use this option to control the amount of heat the Printer uses when printing with the Overlay Ribbon Panel.

- Move the slide to the left to cause less heat to be used while printing.

OR

- Move the slide to the right to cause more heat to be used.

Using the Image Color tab

You can use this option to control the image quality. The Sharpness, Contrast and Gamma settings are controlled here.

The color balance for yellow, magenta and cyan are adjusted with these settings.

Move the slide to the left to cause less of the particular option to be used in the printing process.
OR
Move the slide to the right to cause more of the particular option to be used.

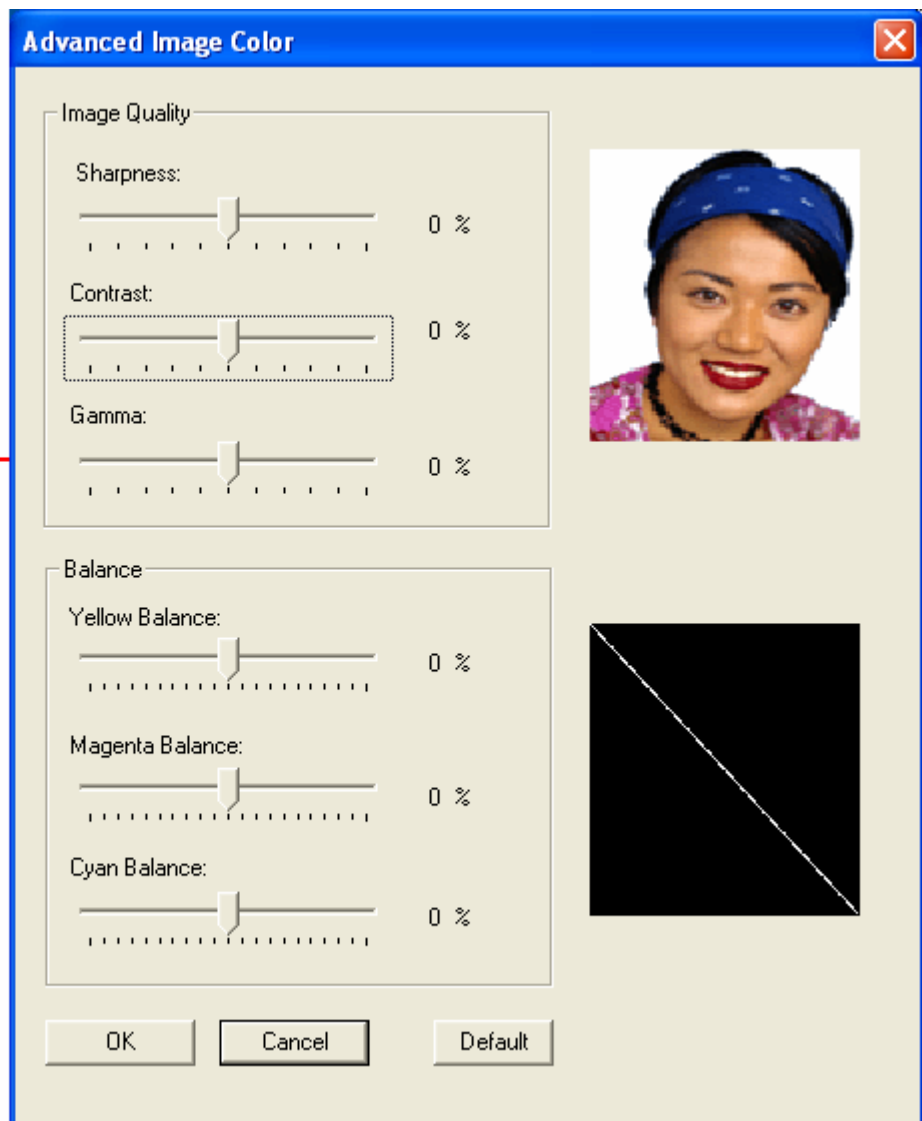

Changing the Color Profile Selection for the DTC4500

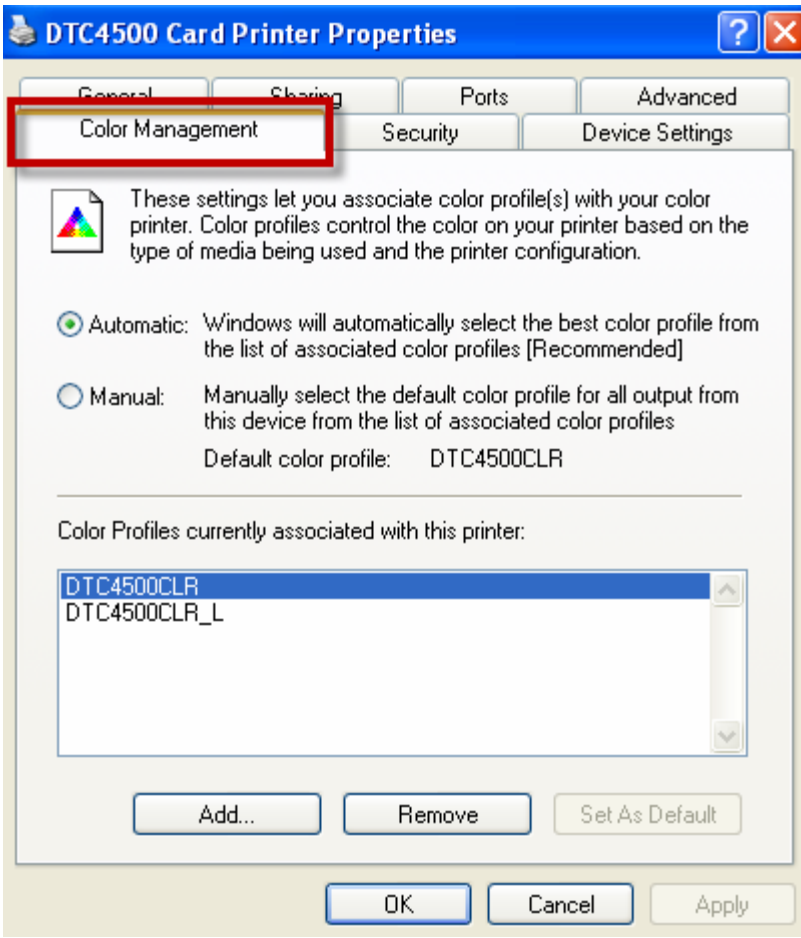
Step	Procedure
1	<p>a. From your computer's startup menu, select Settings > Printers and Faxes (Windows XP) or Settings > Printers (Windows 2000).</p> <p>b. Double click on the DTC4500 Card Printer under the Printers window.</p> <p>c. Select Properties under the Printer drop-down menu. (Note: This will bring up the DTC4500 Card Printer Properties window.)</p> <p>d. Select the Color Management Tab</p> <p>e. The Default color profile is DTC4500CLR.</p>  <p>The screenshot shows the 'DTC4500 Card Printer Properties' dialog box with the 'Color Management' tab selected. The 'Automatic' radio button is selected, and the 'Default color profile' is 'DTC4500CLR'. A list of color profiles shows 'DTC4500CLR' and 'DTC4500CLR_L'. Buttons for 'Add...', 'Remove', 'Set As Default', 'OK', 'Cancel', and 'Apply' are visible.</p>

Changing the Color Profile Selection for the DTC4500

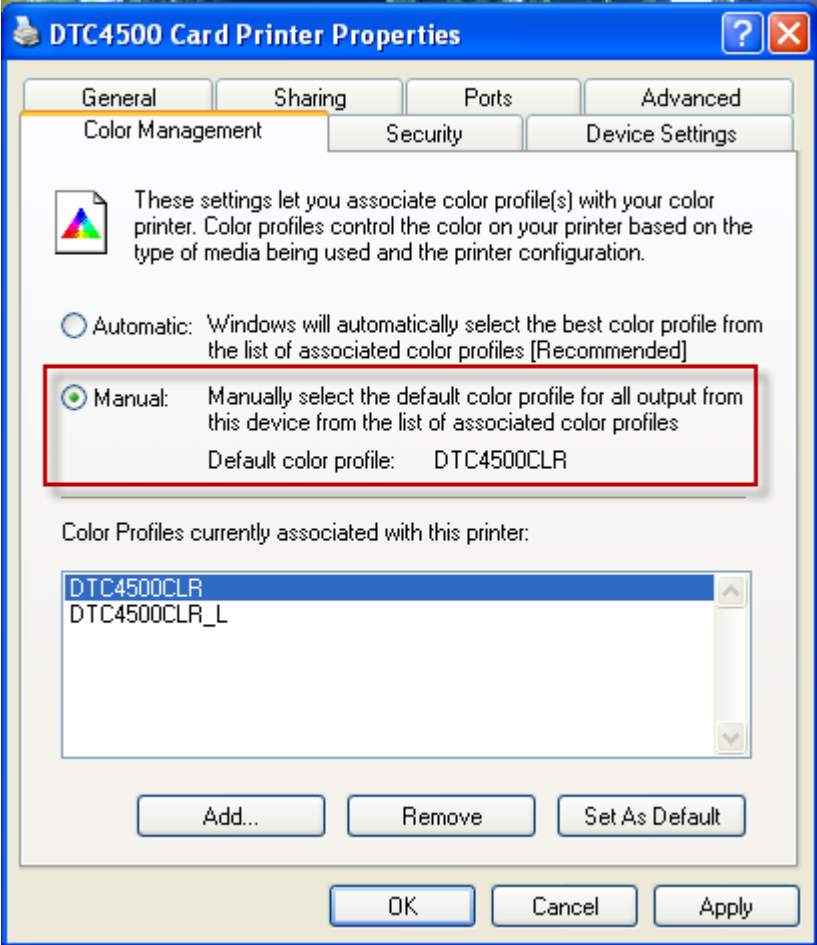
Step	Procedure
3	<p>Click Manual.</p>  <p>The screenshot shows the 'DTC4500 Card Printer Properties' dialog box with the 'Color Management' tab selected. Under 'Color Management', the 'Manual' radio button is selected and highlighted with a red box. The text next to it reads: 'Manually select the default color profile for all output from this device from the list of associated color profiles. Default color profile: DTC4500CLR'. Below this, a list of color profiles is shown with 'DTC4500CLR' selected. At the bottom of the dialog are buttons for 'Add...', 'Remove', 'Set As Default', 'OK', 'Cancel', and 'Apply'.</p>
4	<p>Default Color Profile</p> <p>Select the DTC4500CLR for a Color Profile that attempts to match the DTC550 card printer from FARGO.</p> <p>OR</p> <p>Optional Color Profile</p> <p>Select the DTC4500 CLR_L for a Color Profile that attempts to match the Persona C30(e) and FARGO DTC400(e) card printers..</p>
5	<p>Click Set as Default.</p>

Using the Image Calibrate tab

Use the Image Calibrate tab to control the position of the printable area in relation to the card.

Use the Image Position controls to adjust the position of the overall print area to be precisely centered on a card.

Use the Calibrate tab to control the position of the printable area in relation to the card.

Use the Vertical adjustment to move the image toward:

- The rear of the Printer if a positive number is entered.
- The front of the Printer if a negative number is entered.

Use the Horizontal adjustment to move the image toward:

- The card output side of the Printer if a positive number is entered.
- The card input side of the Printer if a negative number is entered.

The maximum value for the Vertical and Horizontal adjustments is ± 100 pixels (10 pixels = about .03"/.8mm).

The Vertical and Horizontal adjustment arrows point to within the Image Position window, which represents the direction that the printed image moves.

Using the Magnetic Encoding Tab

Select the **Magnetic Encoding** tab to display options for controlling the Magnetic Stripe encoding process. You should use these options only if the Printer has an optional Magnetic Stripe Encoding Module installed.

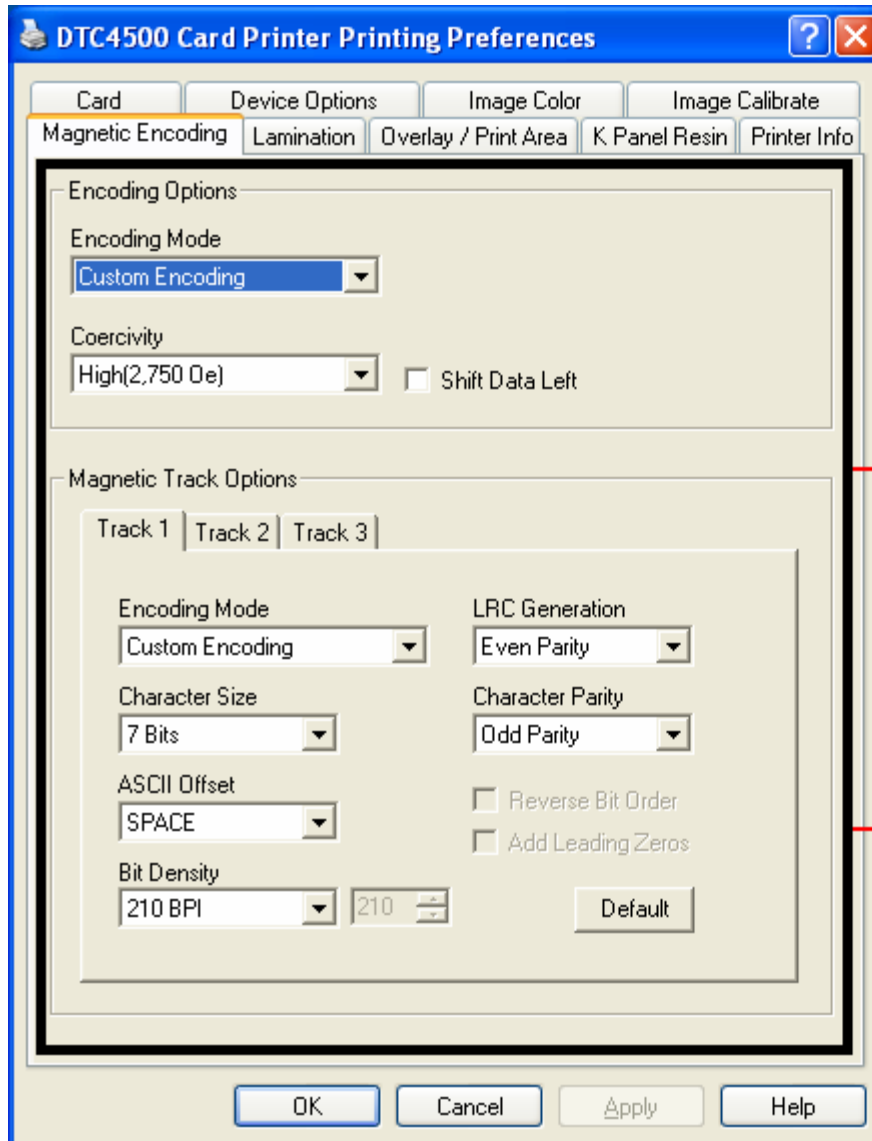

Please see the related tables and procedured below for more details on how to use the Magnetic Encoding tab window.



Use the Default button to reset defaults for the current Track tab only.

Using the Magnetic Encoding Tab – ISO Standards

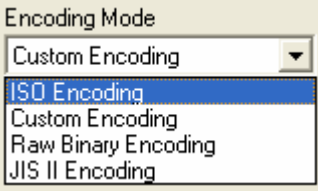
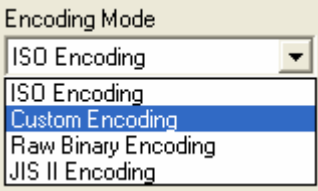
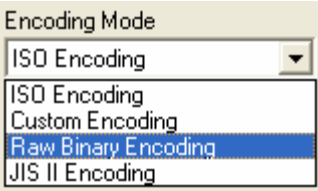
You can change the encoding mode and coercivity setting or modify the ISO standards for Tracks 1, 2 and 3. This can be done by correctly modifying these Magnetic Encoding options.

Window TAB	Procedure	Procedure (continued)
 <p>Encoding Mode Custom Encoding ISO Encoding Custom Encoding Raw Binary Encoding JIS II Encoding</p>	<p>If you select ISO Encoding, you send down a formatted set of characters.</p>	<p>This selection activates the track tabs. However, all functions on the Track tabs are inactive or gray and display ISO defaults, which are the defaults listed for each track below. The Shift Data Left check box remains unchecked and inactive.</p>
 <p>Encoding Mode ISO Encoding Custom Encoding Raw Binary Encoding JIS II Encoding</p>	<p>If you select Custom Encoding, all options are active.</p>	<p>The Default is ISO Encoding. (Note: The defaults are the same as the ISO Encoding defaults.) All functions on the Magnetic Track Options tabs are active.</p>
 <p>Encoding Mode ISO Encoding ISO Encoding Custom Encoding Raw Binary Encoding JIS II Encoding</p>	<p>If you select Raw Binary Encoding, you send down a raw binary string rather than a formatted set of characters.</p>	<p>The Coercivity dropdown function is active and the Shift Data Left checkbox is not active. All functions on the Magnetic Track Options tabs are inactive except for Bit Density.</p>

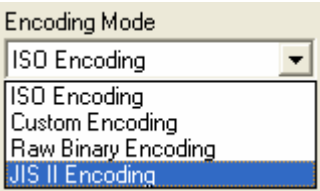
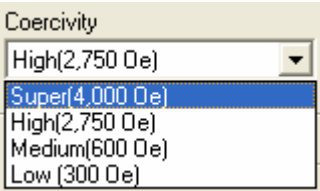
Using the Magnetic Encoding Tab – ISO Standards

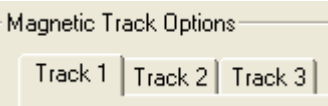
Window TAB	Procedure	Procedure (continued)
	<p>If you select JIS II Encoding, specific standards are used.</p>	<p>This selection disables all the Magnetic Track Options tabs. It also disables the Coercivity dropdown function and Shift Data Left checkbox option.</p> <p>The default Coercivity is 600 Oe.</p>
	<p>Select the Coercivity option (Oersted) that matches the card type.</p>	<ul style="list-style-type: none"> • Super Coercivity =4000 Oersted • High Coercivity = 2750 Oersted • Medium Coercivity=600 Oersted • Low Coercivity = 300 Oersted
	<p>Select this option to shift the recorded magnetic data to the left-hand side of the card's Magnetic Stripe.</p>	<p>This is useful in situations that require cards to be readable with insert type readers.</p>
	<p>Select the Magnetic Track Selection option to specify which track is to be configured through the Magnetic Track Options.</p>	<p>This applies if the application being used <u>requires</u> customization of the standard ISO encoding process.</p>

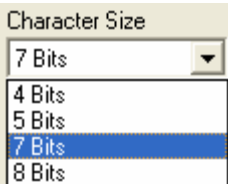
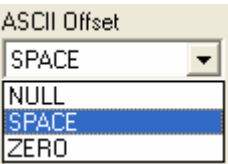
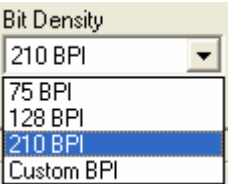

Using the Magnetic Encoding Tab – Custom Encoding or Raw Binary Encoding Mode

You can change the Magnetic Track options for Tracks 1, 2 and 3 when using the Custom Encoding or Raw Binary Encoding Mode. These options are not available for ISO or JIS II encoding.

Window TAB	Procedure	Procedure (continued)
	<p>Select 4 Bits to change the bits per character to 4 BPC. (Note: This is the default for Track 3).</p> <p>Select 5 Bits to change the bits per character to 5 BPC. (Note: This is the default for Tracks 2 and 3).</p>	<p>Select 7 Bits to change the bits per character to 7 BPC. (Note: This is the default for Track 1).</p> <p>Select 8 Bits to change the bits per character to 8 BPC.</p>
	<p>Select NULL to change the ASCII Offset to NULL.</p> <p>Select SPACE to change the ASCII Offset to SPACE. (Note: This is the default for Track 1.)</p>	<p>Select ZERO to change the ASCII Offset to ZERO. (Note: This is the default for Tracks 2 and 3.)</p>
	<p>Select 75 BPI to change the bits per inch to 75 BPI. (Note: This is the default for Track 2.)</p> <p>Select 128 BPI to change the bits per inch to 128 BPI.</p>	<p>Select 210 BPI to change the bits per inch to 210 BPI. (Note: This is the default for Tracks 1 and 3.)</p> <p>Select Custom BPI, which enables the custom BPI text box. (Note: The lower limit is 75 and upper limit is 210.)</p>

Using the Magnetic Encoding Tab – Custom Encoding or Raw Binary Encoding Mode

You can change the Magnetic Track options for Tracks 1, 2 and 3 when using the Custom Encoding or Raw Binary Encoding Mode. These options are not available for ISO or JIS II encoding.

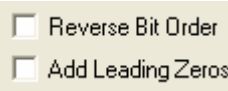
Window TAB	Procedure	Procedure (continued)
 <p>LRC Generation Even Parity No LRC Even Parity Odd Parity</p>	<p>Select No LRC to change the LRC Generation to none.</p> <p>Select Even Parity to change the LRC Generation to Even Parity. (Note: This is the default for all tracks.)</p>	<p>Select Odd Parity to change the LRC Generation to Odd Parity.</p>
 <p>Character Parity Odd Parity No Parity Even Parity Odd Parity</p>	<p>Select No Parity to change the Character Parity to none.</p> <p>Select Even Parity to change the Character Parity to Even Parity.</p>	<p>Select Odd Parity to change the Character Parity to Odd Parity. (Note: This is the default for all tracks.)</p>
 <p><input type="checkbox"/> Reverse Bit Order <input type="checkbox"/> Add Leading Zeros</p>	<p>Reverse Bit Order is used to reverse the character bits.</p>	<p>Add Leading Zeros is used to add a set number of leading zeros to the magnetic string in order to move the starting point of the encoded data.</p>

Reviewing the ISO Track Locations

The magnetic Encoding Module encodes onto tracks in accordance with an ISO 7811-2 Magnetic Stripe. For track locations, review the display below.

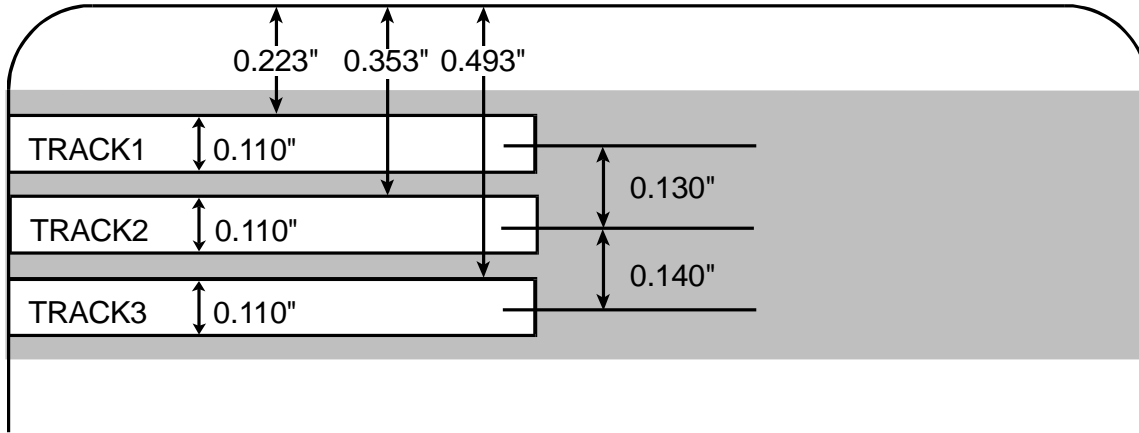

Reviewing the Sample String

- Track 1: ~1%JULIEANDERSON^1234567890?
- Track 2: ~2;1234567890987654321?
- Track 3: ~3;1234567890987654321?

Track	Start Sentinel	End Sentinel	Field Separator	Valid Characters	Maximum Number of Characters
Track 1	%	?	^	ASCII 32-95 (See the table below.)	78
Track 2	;	?	=	ASCII 48-63 (See the table below.)	39
Track 3	;	?	=	ASCII 48-63 (See the table below.)	106

Sending the Track Information

Magnetic track data is sent in the form of text strings from the application software to the Printer Driver.

- In order for the Printer Driver to differentiate between Magnetic Track data and the rest of the printable objects, specific characters must be added to the magnetic data to be encoded.
- These specify the data that is to be encoded, the tracks to encode and mark the start and stop of the data string. In some cases, these specific characters are automatically added to the string of track data by ID software applications.
- In most cases, the user must carefully add these characters to the string of Magnetic Track data. If these characters are not added to the track data, the text intended for the Magnetic Track will appear as printed text on the card. To avoid this, track information must be entered as described below.

Step	Procedure
1	<p>When entering track data, the ~ (tilde) character is entered first, followed by the track number (1, 2 or 3) on which the data should encode. This is followed by the data to be encoded.</p> <ul style="list-style-type: none"> • The first character of this data string must be the track's specific Start Sentinel (SS) and the last character must be the specific End Sentinel (ES). • The characters or data in between the SS and ES can include all of the valid characters specific to each track. • The number of these characters, however, is limited by each track's maximum character capacity. • When segmenting track data, the appropriate Field Separator (FS) must be used. The table below shows the SS, ES, FS and the valid characters defined for each track.

Reviewing the ASCII Code and Character Table

ASCII Code	Character	ASCII Code	Character	ASCII Code	Character
32	space	56	8	80	P
33	!	57	9	81	Q
34		58	:	82	R
35	#	59	;	83	S
36	\$	60	<	84	T
37	%	61	=	85	U
38	and	62	>	86	V
39	'	63	?	87	W
40	(64	@	88	X
41)	65	A	89	Y
42	*	66	B	90	Z
43	+	67	C	91	[
44	'	68	D	92	\
45	-	69	E	93]
46	.	70	F	94	^
47	/	71	G	95	_

Reviewing the ASCII Code and Character Table

ASCII Code	Character	ASCII Code	Character	ASCII Code	Character
48	0	72	H		
49	1	73	I		
50	2	74	J		
51	3	75	K		
52	4	76	L		
53	5	77	M		
54	6	78	N		
55	7	79	O		

Using the Lamination tab

Refer to **Section 5: Lamination Module** for more information.

DTC4500 Card Printer Printing Preferences

Card **Device Options** Image Color Image Calibrate

Magnetic Encoding **Lamination** Overlay / Print Area K Panel Resin Printer Info

Lamination Position

+H [Diagram of card with patch] -H

Horizontal: 0

← Direction Card Travels through Printer

Lamination Speed

Transfer Dwell Time 2.0 seconds per inch

Lamination Side

Laminate Front Side

Lamination Type

Cartridge 1 Cartridge 2

Clear Film Lamination

Transfer Temperature 130.0 Celsius

Automatically detect installed Laminate for every print

OK Cancel Apply Help

Adjust the Transfer Dwell Time to control the Lamination Dwell Time or through-put speed of a card in seconds per inch and with the Lamination Temperature.

- Default = 2.0 seconds per inch
- Upper Limit = 5.5 seconds per inch
- Lower Limit = 0.8 seconds per inch

Use the Lamination Position control to adjust the horizontal position of the PolyGuard Overlamine.

- To adjust the Lamination position, click on the Horizontal adjustment arrows.
- To move the overlamine more toward the card output side of the Printer, enter a positive number.
- To move the overlamine more toward the card input side of the Printer, enter a negative number.

The adjustment arrows point in the direction the patch will move on the card. The maximum value for the Horizontal adjustment is ±100 Pixels (10 Pixels = about .03/.8mm). The default is 0.

Using the Lamination tab

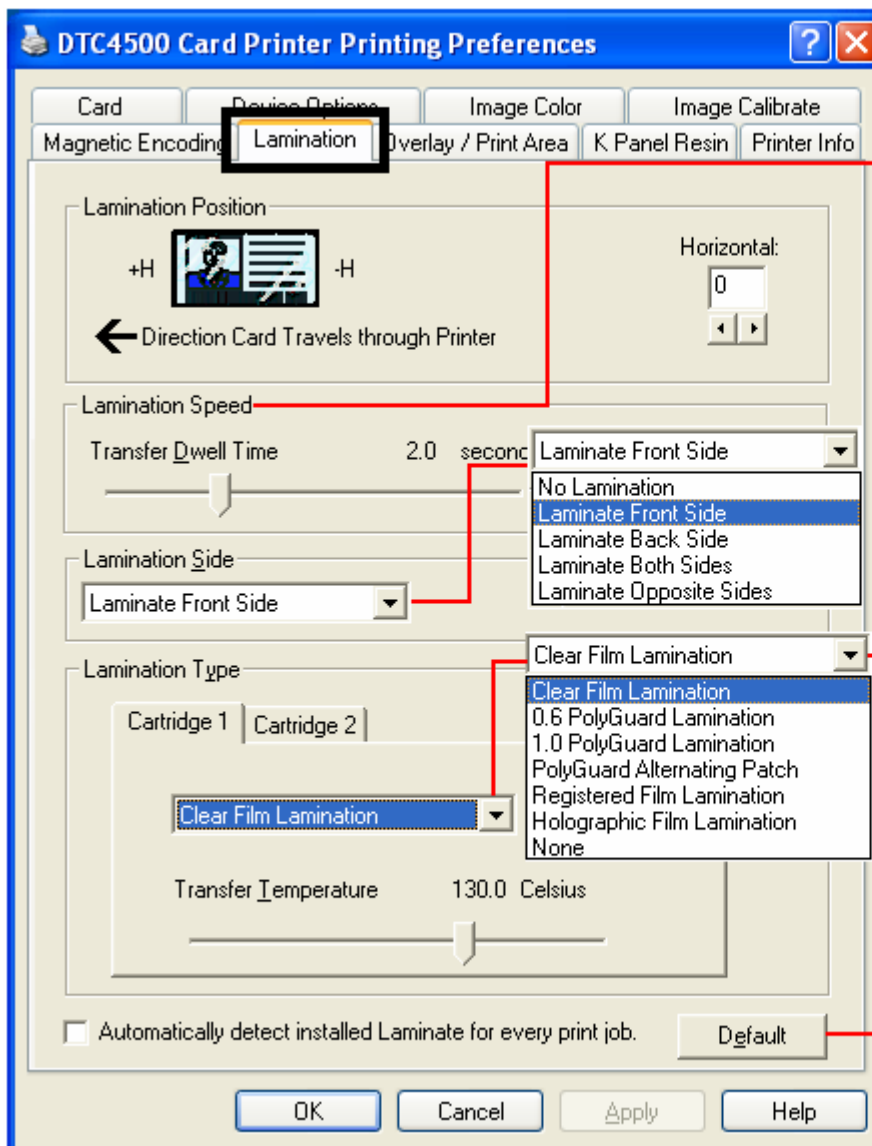

Move the slide to the left to reduce the Transfer Dwell Time or to the right to increase the Dwell Time for your Lamination Speed.

Select the Lamination Type options based on the current Lamination media. Film Lamination and PolyGuard Lamination are the two overlaminates.

- Select Clear Film Lamination if the Thermal Transfer Film Overlamine type is installed in the Lamination Module.
- Select 0.6 PolyGuard Lamination or 1.0 PolyGuard Lamination for either patch thickness. Select the option based on the PolyGuard material thickness.
- Select Registered Film Lamination for a registered thermal transfer film.
- PolyGuard Alternating Patch and Holographic Film Lamination are options.

Click on Default to return Transfer Dwell Time and Transfer Temperature to the Default settings for the Lamination Type (used).

Using the Overlay / Print Area tab

This option is helpful if, for example, you would like to omit the printing or block out the overlay for a signature or printing around a card's smart chip or magnetic stripe. Refer to [Using the Defined Area Option](#) for a specific procedure that relates to this tab.

Use this tab to control and customize where the Overlay (O) Panel and/or the print area appear on a card. By default, this option is set to print and overlay the entire card.

Select **For Print and Overlay** for the defined area to apply to both the printing and overlay process.
OR
Select **For Overlay Only** for the defined area to apply only to the overlay process. In this mode, printing will still be allowed over the entire card and only the overlay will be affected.
OR
Select **For Print Only (No Overlay)** for the defined area to apply only to the print process. In this mode, the overlay is completely disabled so it will not be applied.

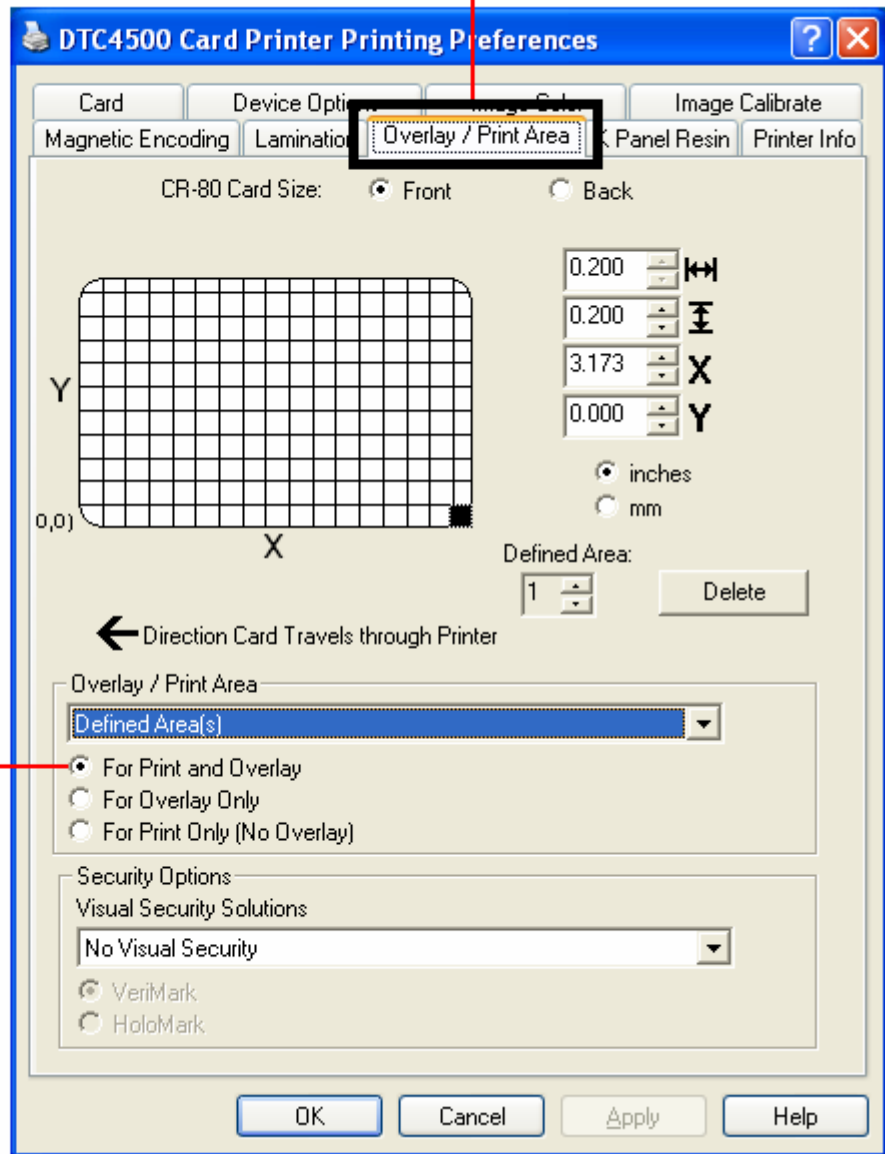

Using the Overlay / Print Area tab

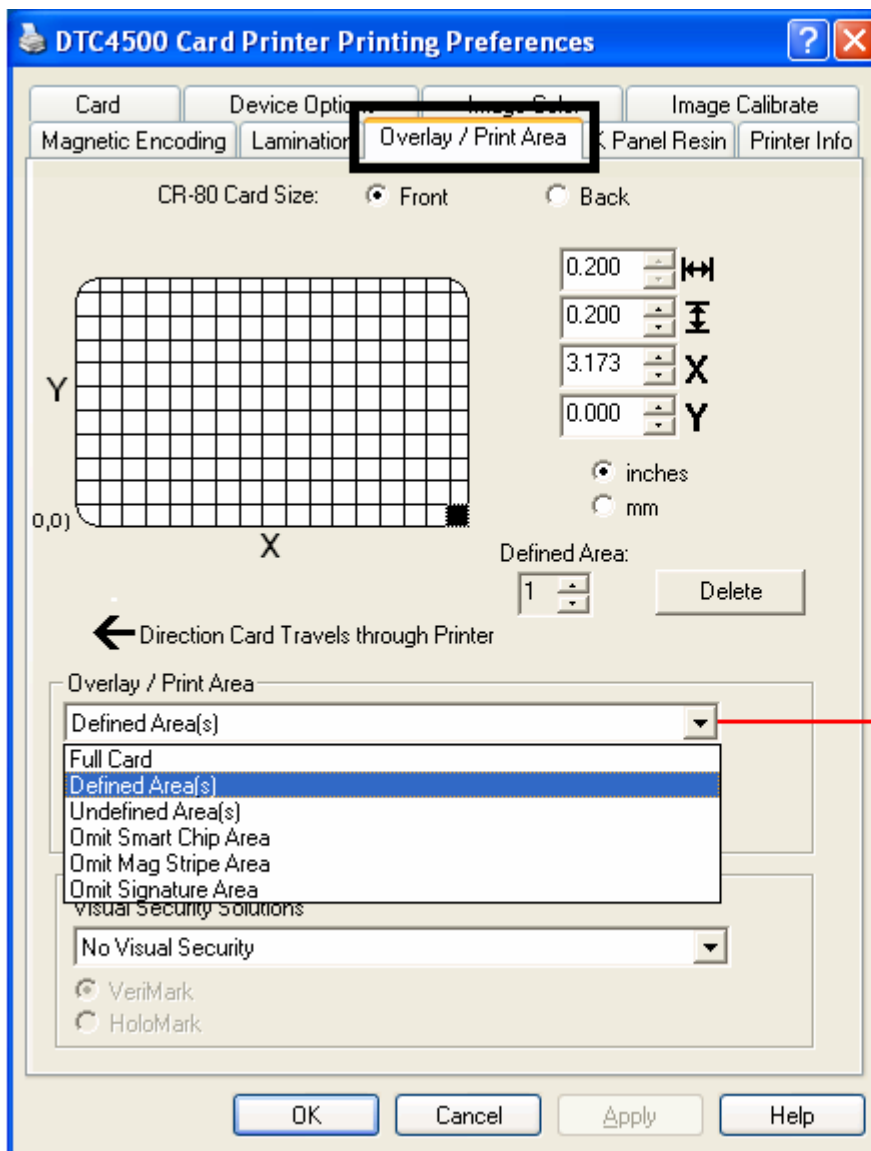

Select **Full Card** for the Printer to overlay and/or print the entire card.

OR

Select **Defined Area(s)** for the Printer to overlay and/or print only in the selected and defined area or areas.

OR

Select **Undefined Area(s)** for the Printer to overlay and/or print only in the space outside the selected and defined area.

OR

Select **Omit Smart Chip Area** for the Printer to overlay and/or print only in the space outside the standard location of a smart chip.

OR

Select **Omit Magnetic Stripe Area** for the Printer to overlay and/or print only in the space outside the standard location of an ISO Magnetic Stripe.

OR

Select **Omit Signature Area** for the Printer to overlay and/or print only in the space outside the standard location of a signature panel.

Using the Overlay / Print Area tab

The Visual Security Solutions dropdown menu list is used to enable and select which type of visual security will be used.

The Visual Security dropdown list is selectable only on the Front side. Visual Security is not an option for the back side.

These actions occur when one of the Visual Security locations is selected.

- The Overlay / Print Area will be disabled.
- The Security Options become selectable.

Select **Landscape** under **Orientation** on the Card tab to use the Visual Security Solutions (A to D).

Select **Portrait** under **Orientation** on the Card tab to use the Visual Security Solutions (E to H).

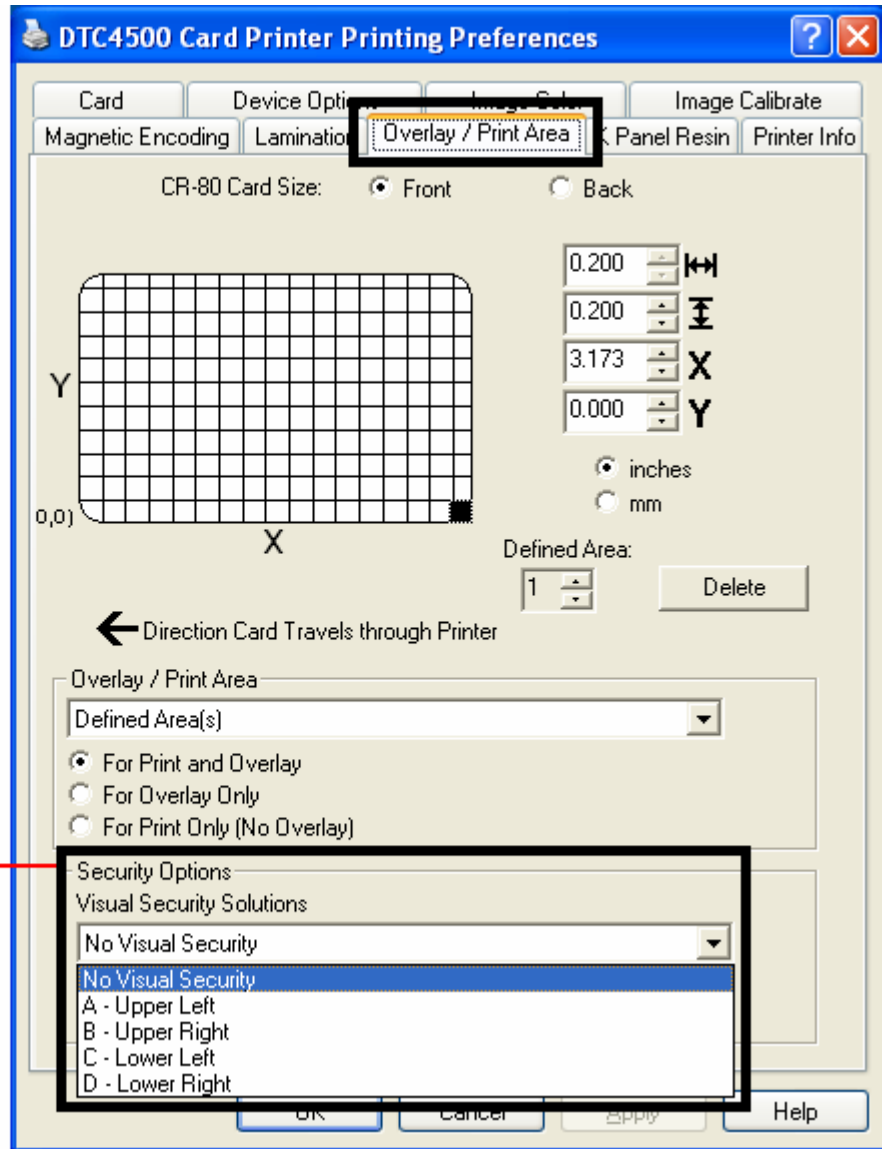

Using the K Panel Resin tab

Use this tab to control where the resin black (K) Panel of a full-color Ribbon is printed. Refer to **Using the Defined Area Option** for a specific procedure that relates to this tab.

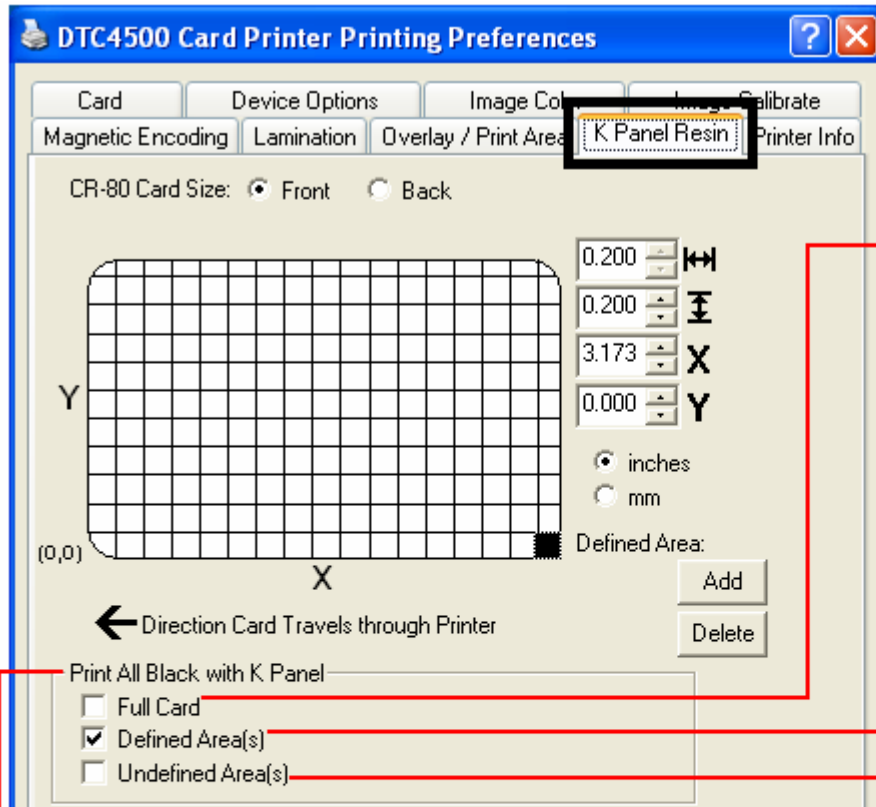

Select **Full Card** for the Printer Driver to print the resin black (K) panel for all black found within all areas of the image.

Select **Defined Area(s)** for the Printer Driver to print the resin black (K) panel for all black found only in a desired and defined area or areas.

Select **Undefined Area(s)** for the Printer Driver to print the resin black (K) panel for all black found only in the space outside the defined areas. In the card grid, black indicates the area in which the resin black (K) panel will be printed.

Select one of the three options listed under Print All Black with K Panel if the black text or bar codes are not TrueType fonts and/or are not printing with the resin black panel. When these options are not selected, the Printer Driver will automatically print all TrueType black text and bar codes only with the Resin Black (K) Panel of the Print Ribbon.

Using the K Panel Resin tab

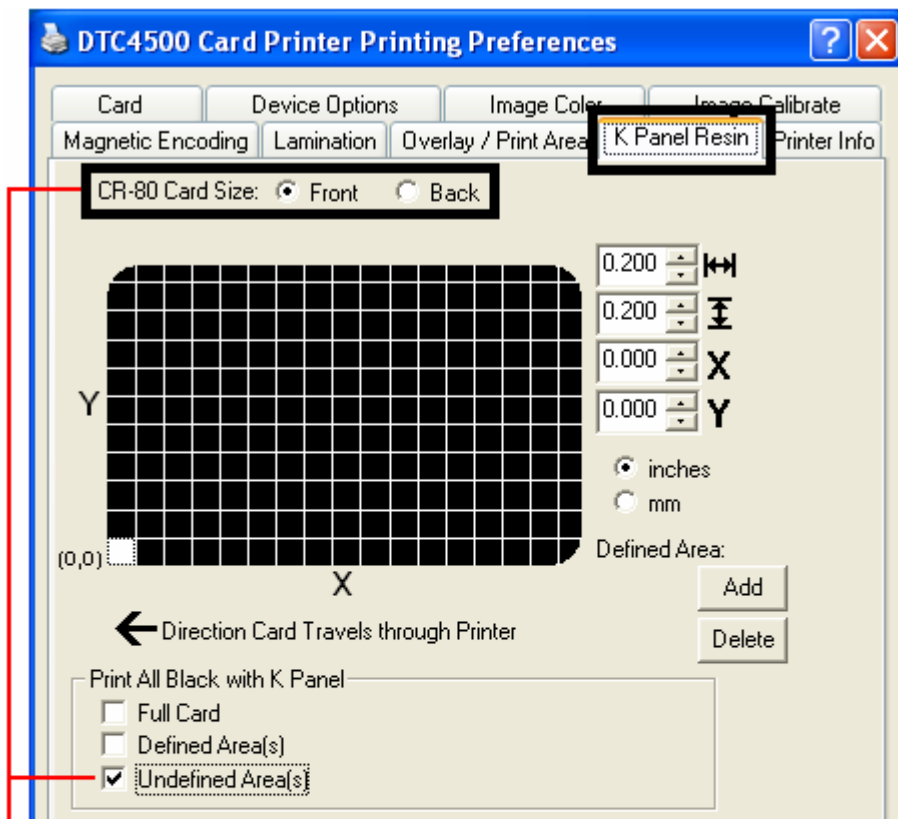

Select **Undefined Area(s)** for the Printer Driver to print the resin black (K) panel for all black found only in the space outside the defined areas.

In the card grid, black indicates the area in which the resin black (K) panel will be printed.

Using the K Panel Resin tab

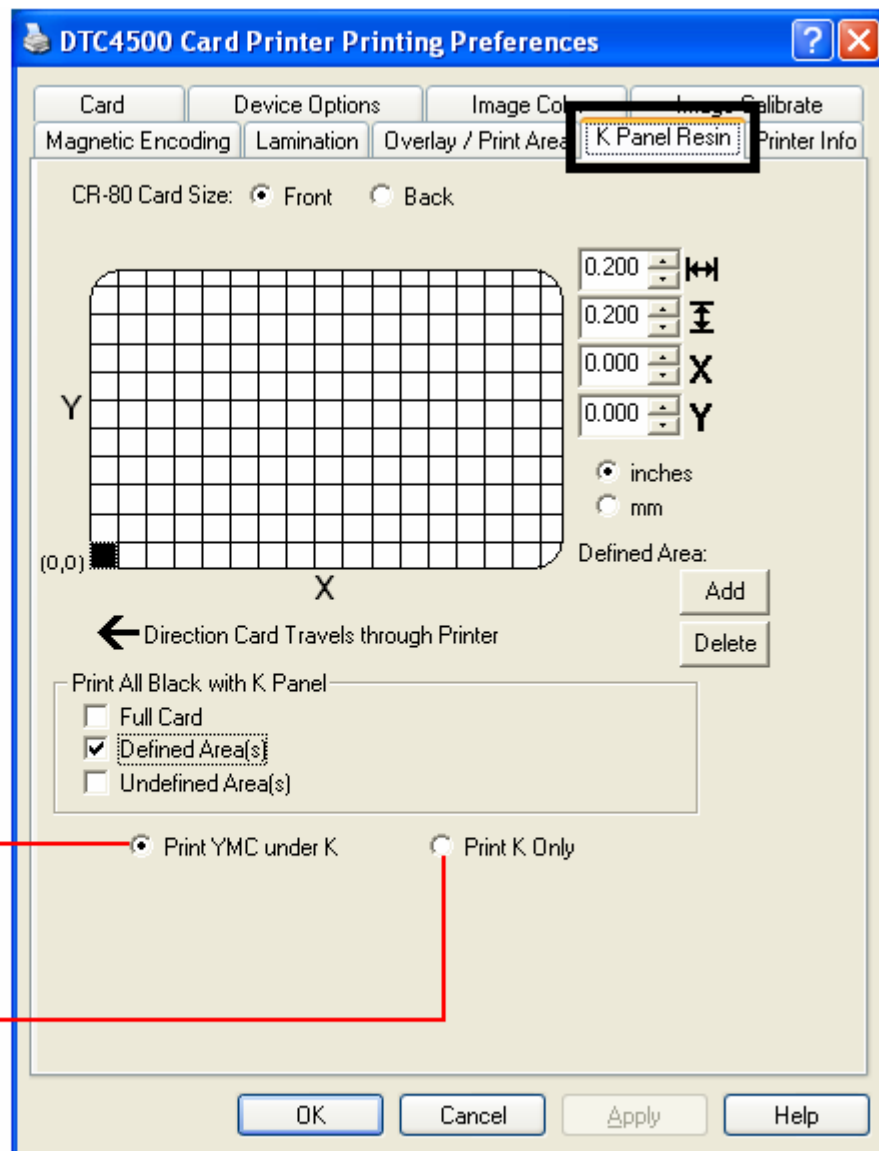

Select the **Print YMC under K** option to print all black in the designated areas with the Yellow (Y), Magenta (M) and Cyan (C) Ribbon panels directly beneath the resin black (K) panel and provide a gradual transition between the resin black text or bar codes.

Select **Print K Only** if printing resin black onto a white background to maximize the sharpness of printed text and bar codes and print all black in the designated areas with the resin black (K) panel.

Using the Printer Info tab

Use the options on this tab to view information about the Ribbon, Laminate, Card Count, Printer Serial #, Firmware version, and Reorder Media #'s installed in the Printer.

DTC4500 Card Printer Printing Preferences

Card Device Options Image Color Image Selection
Magnetic Encoding Lamination Overlay / Print Area K Panel Resist **Printer Info**

Ribbon
Type: YMCFKOK - Secure Fluorescing Ribbon
Reorder #: 45212 Lot #: Unknown
Empty Full

Lamination - Cartridge 1
Type: None
Reorder #: Unknown
Empty Full

Lamination - Cartridge 2
Type: 0.6 PolyGuard Lamination
Reorder #: 82600
Empty Full

Printer
Card Count: 3067
Serial #: 00000002
Version: 0.0.6.13

OK Cancel Apply Help

Here are guidelines for automatic positioning on the Printer Info tab.

Ribbon Level: Type, Reorder Number, and Gauge Indicator.

Lamination - Cartridge 1 Level: Type, Reorder Number and Gauge Indicator. Visible only when this cartridge is detected.

Lamination - Cartridge 2 Level: Type, Reorder Number, and Gauge Indicator. Visible only when this cartridge is detected.

Printer - Card Count, Serial Number, and Version Number are provided here.

Section 5: Card Lamination Module.

The DTC4500 supports the attachment of an optional Card Lamination Module. This Module can be ordered pre-installed on the Printer from the factory or can be ordered separately as a field upgradeable Module.

Once attached, the Card Lamination Module allows you to apply Fargo certified overlaminates for more secure, tamper-resistant cards. This section explains all aspects of the Card Lamination Module's operation.

- See [Selecting the Calibrate Laminator tab](#) for more information on this tab.
- See [Using the Lamination tab](#) for more information on this tab.

IMPORTANT! Fargo Card Printers require highly specialized Lamination Material to function properly. To maximize Printer life, reliability, printed card quality and durability, you must use only Fargo Certified Supplies. For this reason, your Fargo warranty is void, where not prohibited by law, if you use non-Fargo Certified Supplies. To order additional materials, please contact your authorized reseller.



Danger: The Printer's Transfer Roller can reach temperatures exceeding 350° F (175° C). Use extreme caution when operating the Laminator. Never touch the Transfer Roller unless the Printer has been turned off for at least 20 to 30 minutes.

Reviewing the Card Lamination Module



Choosing a Proper Location

Follow these guidelines:

- Place the unit in a location with adequate air circulation to prevent internal heat build-up.
- Use the Printer's dimensions (18.9" H x 18.7" W x 9.2" D) as a guideline for the minimum clearances to the unit. (**Note:** Allow for adequate clearance in front of the unit to accommodate the height of the unit with its Covers open.)
- Do not install the unit near heat sources, such as, radiators or air ducts.
- Do not install the unit in a place subject to direct sunlight, excessive dust, mechanical vibration or shock.

Preventing Moisture Condensation

If the unit is brought directly from a cold to a warm location or if the unit is placed in a very damp room, moisture may condense inside the unit. (**Note:** If this condition occurs, print quality may not be at its optimum level.)



Follow this guideline:

- Leave the unit turned OFF in a warm, dry room for several hours before using it. (**Note:** This will allow the moisture to evaporate.)

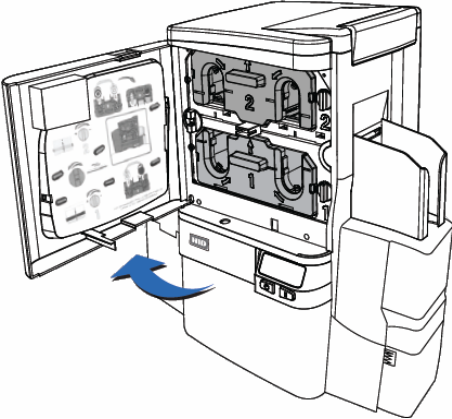
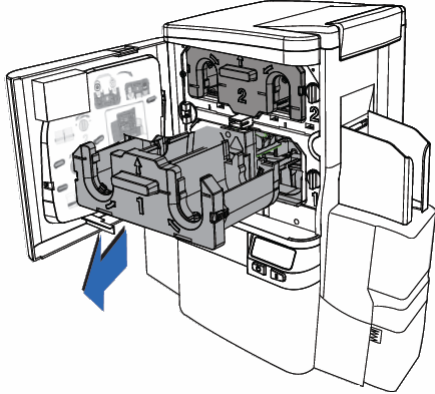
Installing the Laminates

Step	Procedure
1	<p data-bbox="266 401 594 432">Open the lamination door</p> 
2	<p data-bbox="266 926 711 957">Remove #1 overlaminate cartridge</p> 

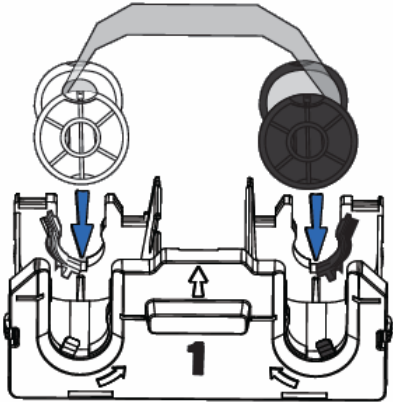
Installing the Laminates

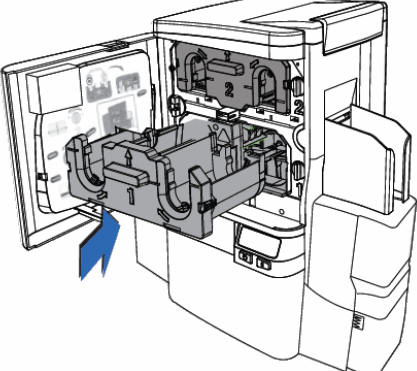
Step	Procedure
3	<p>Load lamination rolls into the cartridge until hearing a click.</p> 
4	<p>Tighten the lamination roll.</p> 
5	<p>Insert the overlamine cartridge until hearing a click.</p> 

Installing the Laminates

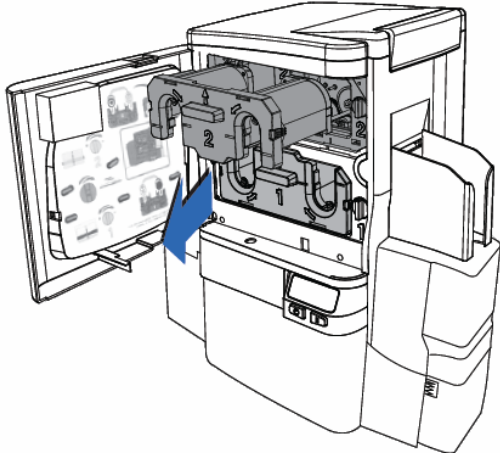
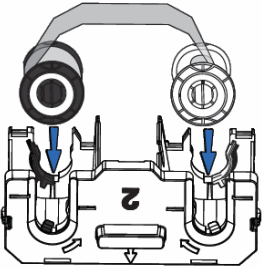
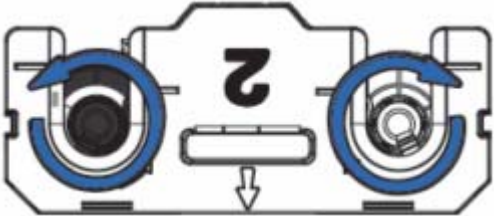
Step	Procedure
6	<p>Remove #2 overlaminate cartridge</p> 
7	<p>Load lamination rolls into the cartridge until hearing click.</p> 
8	<p>Tighten the lamination roll.</p> 

Installing the Laminates

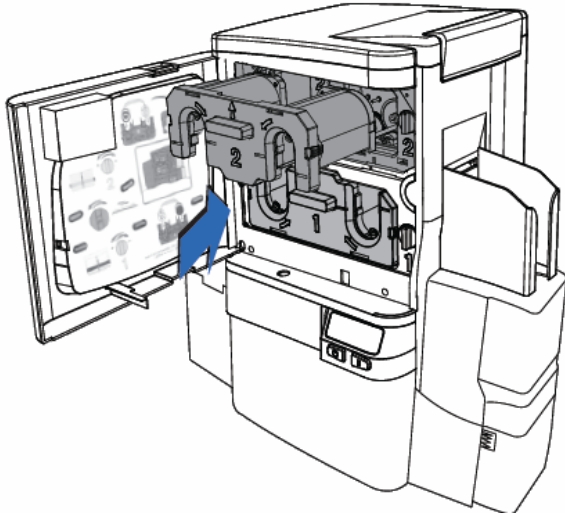
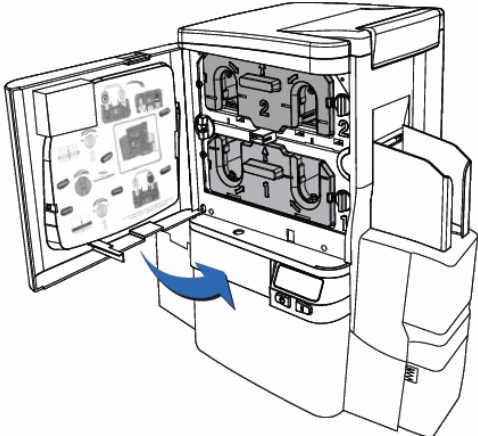
Step	Procedure
9	<p data-bbox="264 365 951 401">Insert the overlamine cartridge until hearing a click.</p> 
10	<p data-bbox="264 963 607 999">Close the lamination door.</p> 

Adjusting the Lamination Placement on the Card

The Card Lamination Module provides an adjustable Lamination Placement knob that allows you to fine-tune where the lamination is being placed on the card.

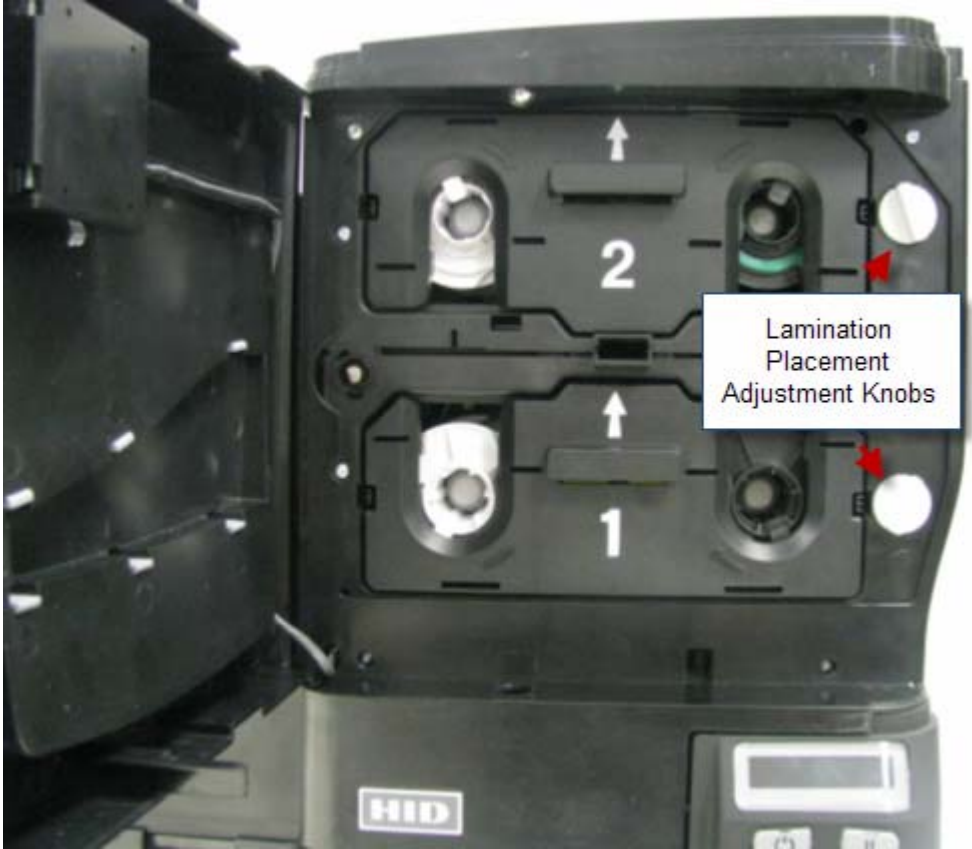
Step	Procedure
1	<ul style="list-style-type: none">• The Lamination Placement Adjustment Knob is the light gray knob to the right of the Lamination Cartridges.• The printer will have one or two film cartridges loaded (depending on whether this is a Single or Dual-Side Lamination Module). 
2	<p>Print a test card to see if the Lamination placement needs to be adjusted.</p> <p>Turn the knob to the right to move the patch toward the front edge of the Lamination Module. Turn the knob to the left to move the patch toward the back edge of the lamination module.</p>

Section 6: Selecting the Fluorescent Panel Ribbon Type

The YMCFKO/YMCFKOK Ribbon is an economical way to add a fully customizable, incremental level of security to your photo identification cards.

- **Process:** This process allows you to configure the data that is printed with the fluorescent panel of an YMCFKO/YMCFKOK Ribbon. (**Note:** Any software program may be used to print the special fluorescent panel of the Ribbon to a card once the Driver and Workbench are set up correctly.)
- **Ribbons:** These Ribbons contain a yellow (**Y**), magenta (**M**), cyan (**C**), and resin black (**K**) panels to create a full color over-the-edge printing identification card. In addition, the Ribbon contains a dye-based fluorescing panel (**F**) which will allow you to print a standard or one-to-one personalized fluorescing image that is completely invisible until exposed to ultraviolet light.

Creating a Custom Fluorescent Image (using the YMCFKO Ribbon)

There are three (3) methods used to accomplish the creation of a custom fluorescent image when using the YMCFKO Ribbon.

- **First Method:** The first method uses the Fargo Workbench Printer Utility to create a static image that will be applied automatically to each card sent to the Printer. Refer to the **Help file for the Fargo Workbench Utility Program and User Guide** or to **Appendix A for Configuring Fluorescent Data (F-Panel for YMCFKO Ribbon)** using the Workbench.
- **Second Method:** The second method (described below) allows the creation of the fluorescent panel image directly from the badge application software. (**Note:** You can now print a unique fluorescent image, such as the card holder's picture on each card.)
- **Third Method:** The third method is described in the **Asure ID Software User Guide**. See the procedure relating to the Fluorescent Panel Ribbon. For more information about Asure ID, please visit our website at <http://www.hidglobal.com/cardIssuance/idSoftware.php>

Creating a Custom Fluorescent Image (using the YMCFKO Ribbon)

Check Invert F-Panel Image to create a negative of the fluorescent image. See below.

- Refers to the ability to cause light or white areas of the image to fluoresce and for dark colors to remain dark on the printed card when exposed to a UV light.
- This was requested because the fluorescent dye color is bright when black light is applied to it.

By default, the dark areas of the image will fluoresce on the card, and the lighter or white areas will have no dye applied.

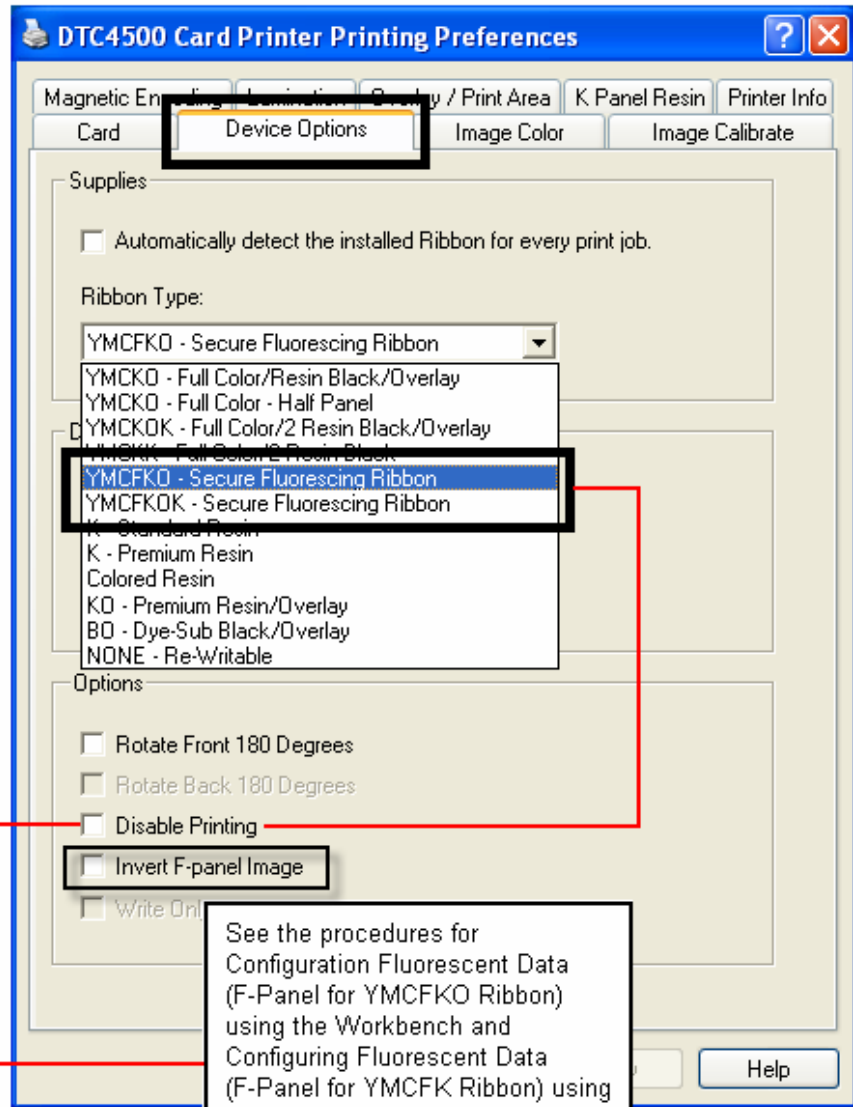

See the procedures for Configuration Fluorescent Data (F-Panel for YMCFKO Ribbon) using the Workbench and Configuring Fluorescent Data (F-Panel for YMCFK Ribbon) using the Application for more details.

Configuring Fluorescent Data (F-Panel for YMCFKO Ribbon) using the Application

This process creates a fluorescent image on your card using a simple text string command in your badge application.

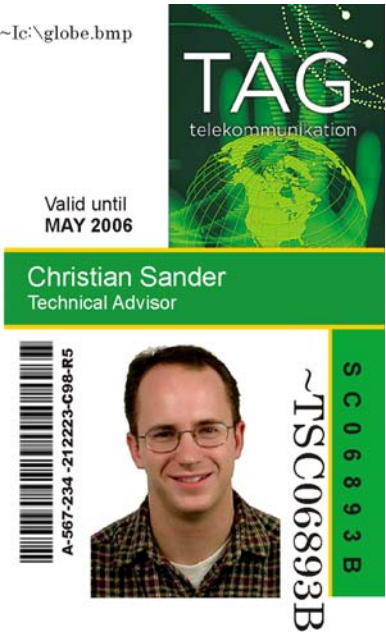
Step	Procedure
1	Creating Fluorescent Text: Create a new text box in your badge application.
2	<p>Type the TEXT that you want to appear as fluorescent and put a ~T before the start of the text with no space after the ~T. The text will start on the card where the ~T begins.</p>  <p>The image shows a sample ID card layout. At the top left, there is a file path: <code>~Ic:\globe.bmp</code>. Below it, the text "Valid until MAY 2006" is displayed. The main header area contains the logo "TAG telekommunikation" with a globe graphic. Below the header, the name "Christian Sander" and title "Technical Advisor" are shown. At the bottom left is a vertical barcode with the number "A-567-234 -212223-C98-R5". To the right of the photo is a vertical fluorescent strip with the text <code>~TSC06893B</code> and <code>SC06893B</code>.</p>

Configuring Fluorescent Data (F-Panel for YMCFKO Ribbon) using the Application

Step	Procedure
3	<p>Creating a Fluorescent Image: In a separate drawing program, create the image that you wish to fluoresce.</p> 

Configuring Fluorescent Data (F-Panel for YMCFKO Ribbon) using the Application

Step	Procedure
4	Create the IMAGE in the actual size that you want it to appear on the card, and save it as a Grayscale or 1 - bit bmp file on the root c:\ directory. <ul style="list-style-type: none"> Do not put spaces in the file name.
5	Create a new text box in your badge application, and type ~I followed by the address of your image (see Display A below). The top left of your image will start at the top left of your text box.
6	Set up the Printer Driver preferences. Refer to Step 8-9 below.
7	Printer will print the fluorescent BMP IMAGE at the ~I position on the card. Printer will print the fluorescent TEXT at the ~T position on the card. BMP Image located at c:\globe.bmp 
8	Set the Ribbon for YMCFKO in the Printing Preferences. (Note: The Automatically detect the installed Ribbon for every print job button may also be used.)
9	Check Invert F-Panel Image to create a negative of the fluorescent image. See below. <ul style="list-style-type: none"> This refers to the ability to cause light or white areas of the image to fluoresce and dark colors to remain dark on the printed card when exposed to a UV light. This was requested because the fluorescent dye color is bright when black light is applied to it. By default, the dark areas of the image will fluoresce on the card and the lighter or white areas will have no dye applied. (Note: This may improve the look of the person's image if used for the Logo.)

Configuring Fluorescent Data (F-Panel for YMCFKO Ribbon) using the Application

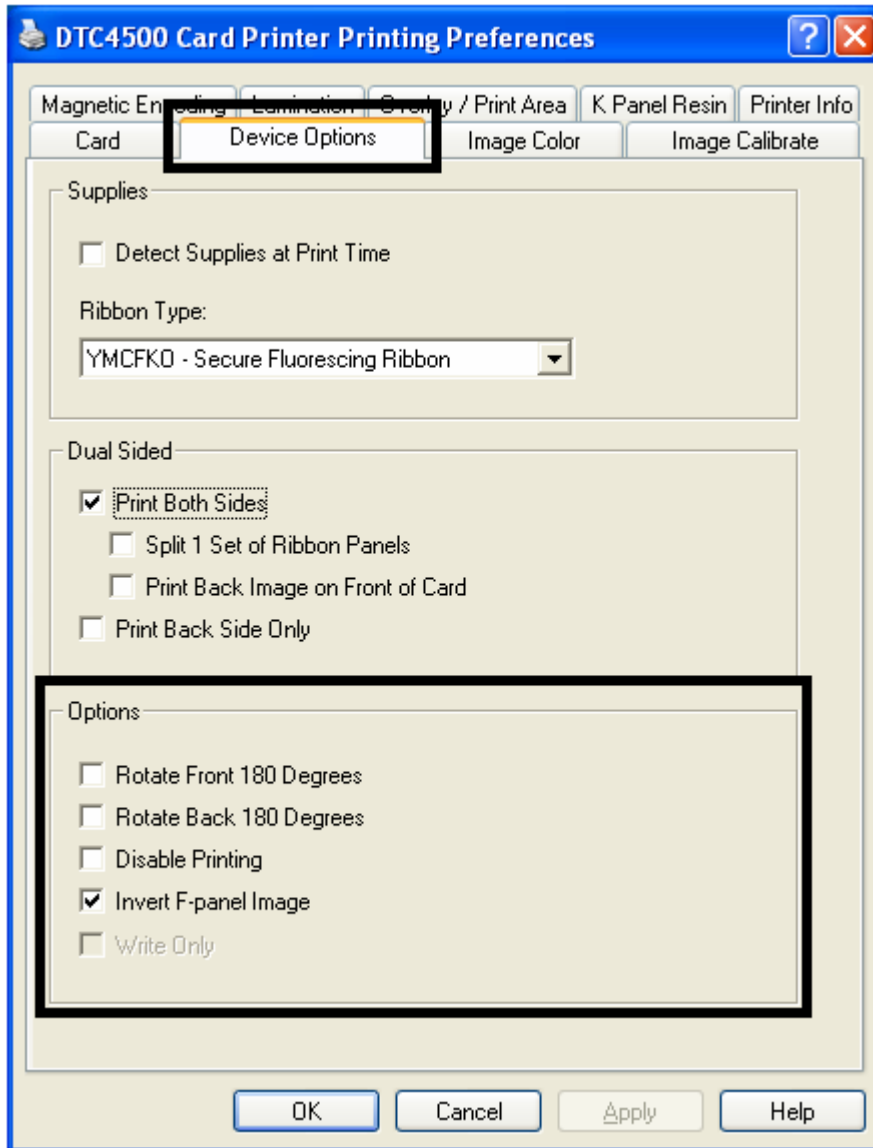

Section 7: System Overview- Troubleshooting

Reviewing the DTC4500 Sequence of Operations

Knowing the sequence of the Printer operation will help troubleshoot the printer.

Step	Process
1	The File information is received from PC.
2	Printer checks the installed Ribbon type stored in memory against the Ribbon type command that was sent from the Printer. If Ribbon type does not match, the Pause button on the right will begin flashing.
3	The Print Stepper Motor engages.
4	The Card Feed Sensor detects leading edge of card, the Headlift Stepper then engages to disengage the input lever.
5	The card feeds through for the alignment pass.
6	The Card Feed Stepper Motor engages to queue card for magnetic encoding (if applicable).
7	The Encoding data is written to the card (if applicable).
8	The Magnetic Encoder verifies while the Stepper reverses the card (if applicable).
9	The Print Ribbon Drive engages (if not already at the yellow Panel).
10	The Print Ribbon Sensor looks for the Yellow Panel. (Note: The Print Ribbon Encoder detects number of revolutions, required to use an entire color Panel.)
11	The Print Stepper Motor engages.

Reviewing the DTC4500 Sequence of Operations

Step	Process
12	The Card Feed Sensor detects the leading edge of card.
13	The Print Stepper Motor queues card to the middle of the platen Roller. All Stop.
14	The Print Headlift Motor engages to the print position.
15	The Print Cover Sensor checks for closed state.
16	The Print Stepper Motor engages.
17	The Ribbon Drive Motor engages.
18	The Image data is burned by the Printhead until the image data is depleted. All Stop.
19	The Thermistor engages the Printhead Cooling Fan to maintain proper operating temperature.
20	The Headlift Motor engages to the queue position.
21	The Print Stepper Motor engages.
22	The Print Ribbon Drive engages.
23	After Ribbon advances a few Encoder clicks, assume the Ribbon is free of card. All stop.
24	Repeat Steps 9 through 22 for the appropriate number of color/overlay Panels.
25	Either the Card is ejected from the singled-sided Printer or the Card Feed Stepper engages to queue the card for the Flipper Table for the dual-sided Printer.
26	All Stop.

Section 8: Troubleshooting

Printer Error Button and Display Message Table

Step	Procedure
1	<p>All Printers have two (2) buttons, one for ON/Off (LEFT) and one for Pause (II) (RIGHT).</p> 
2	<p>The ON/Off button is blue when the Printer is ON. When the Printer enters the Sleep Mode, the button LED is dimmed but still ON.</p>
3	<p>The Pause (II) button will be illuminated blue when the Printer is capable of accepting a print job and is not in an error state.</p> <ul style="list-style-type: none"> • This button LED will continue to stay on while the Printer prints as long as there is no error. • This button LED will also be dimmed when the Printer goes into sleep mode.
4	<p>When an error occurs, the Pause button will no longer be illuminated blue, but will blink red.</p>
5	<p>Press the ON/Off button when Printer is in an error state to cause the action to be cancelled. (Note: If no other error occurs, then the Pause button will illuminate its blue LED.)</p>
6	<p>Press the Pause button when Printer is in an error state to cause the Printer to retry. (Note: It will illuminate its blue LED and retry the failed action.)</p>
7	<p>When downloading an upgrade file, both blue LED's will blink.</p>
8	<p>If a language (other than English) is currently selected:</p> <ul style="list-style-type: none"> • You can press and hold the Pause button during the power-up sequence to change the language back to English.

Using the Error Message Table

This section provides the troubleshooting table for the error message. The DTC4500 has a display that will show the Printer error messages.

- When an error occurs in the Printer, the PC will show the error message on screen with solutions.
- The display will blink in the location needing attention. Those locations include the Printer, Input Hopper, Magnetic Encoder, Flipper, Card Path, Ribbon, and Data/Communication error device.

Each table uses a 3- column presentation to present a specific or Printer error message, its cause and its solution.

- This allows the troubleshooter to identify the error and its cause, and then perform the procedure provided in the solution column.
- This standard mode of identifying the problem and its solution should provide an efficient method of troubleshooting this Printer.
- If you encounter problems beyond the capabilities of these the error message table, you should contact Technical Support. Refer to: [Section 11: HID Global Technical Support](#)

Using the Error Message Table

Error Message	Cause	Solution
# 81 Unable to Feed	The Printer is unable to feed a card from the Card Hopper.	<p>Check the following, then press the Pause button to continue.</p> <ul style="list-style-type: none"> • Verify the Cleaning roller is properly installed on the Ribbon Drawer. • Check for card slippage. If necessary, run the Printer cleaning routine. • Verify that your cards are within the accepted card size range. • Verify the cards are not sticking together.

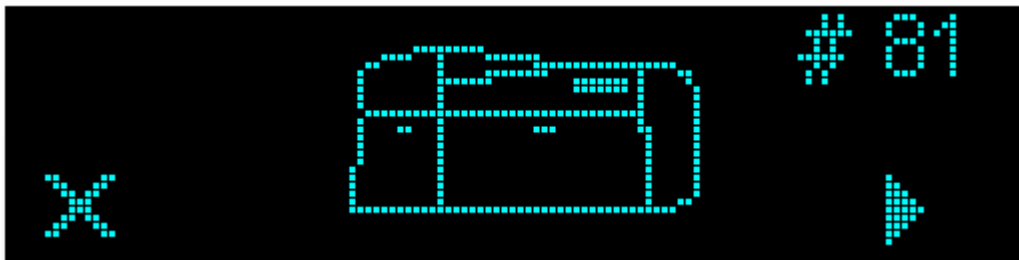

Troubleshooting with the Error Message Table

Error Message	Cause	Solution
# 2 Head Move Error	This is a problem with the Printhead Lift.	Re-start the Printer and try again. <ul style="list-style-type: none"> If this problem persists, call for technical assistance.
# 8 Head Sensor Error	The Printhead Temperature Sensor is not functioning or is not connected properly. OR The Printhead is not cooling properly.	Re-start the Printer and try again. <ul style="list-style-type: none"> If the problem persists, call for technical assistance.
# 9 Reboot Required	Unspecified system error detected by the Printer Firmware.	Re-start the Printer and try again. <ul style="list-style-type: none"> If this problem persists, call for technical assistance.
# 25 Ribbon not Installed	A Ribbon is not installed in the Printer.	Install a Ribbon and retry.
# 30 Mag Verify Error	Magnetic encoding verification failure.	<ul style="list-style-type: none"> Verify correct orientation of card. Try encoding with a different card. Verify cards have the Magnetic Stripe. Replace the Magnetic Encoding Module.

Troubleshooting with the Error Message Table

Error Message	Cause	Solution
# 31 No Mag Module	You are trying to send encoding data, but the Printer is not configured with this Encoder type.	<ul style="list-style-type: none"> • Ensure that no encoding data is being sent with the print job and reprint the card. • Install a Magnetic Encoding Module.
# 38 # 39 # 40 EEPROM Corrupt EEPROM Read Error	EEPROM restored with factory default values.	<p>If changes were made in the Advanced Setting Tab in the Printer Driver, click the Default button to reset these numbers.</p> <ul style="list-style-type: none"> • Re-start the Printer and try again. If this problem persists, call for technical assistance.
# 44 Flipper Jam/ Home Error	<p>A card has become jammed in the Printer's Flipper Table.</p> <p>The Flipper failed to position properly while aligning a card or flipping a card.</p>	<p>Clear any cards in the Flipper Table using the buttons to move the card out. Resume printing.</p> <ul style="list-style-type: none"> • Re-start the Printer and retry. If problem persists call for technical assistance.

Troubleshooting with the Error Message Table

Error Message	Cause	Solution
# 45 No Flip Module installed	Request to print on 2 nd side of card, but no Flipper is installed.	Install a Flipper module.
# 48 Check Lam Power	Lam is connected but not powered.	Power off the Printer, power the Laminator, and then power on the Printer. A damaged Flipper board, E-Card board, or EEPROM could potentially result in this same error.
# 52 Lam Generic Error	Laminator firmware error	Reset power and try again. If this problem persists call for technical assistance.
# 53 Lam Card Jam	A jam occurred somewhere between the Printer and the Laminator	Open covers and clear the obstruction/jam
# 63 Lam Tag Error	There is no material loaded in the Laminator	Load material into the Laminator

Troubleshooting with the Error Message Table

Error Message	Cause	Solution
# 64 # 65 # 66 Reboot Required	Unspecified system error detected by the Printer Firmware.	Re-start the Printer and try again. <ul style="list-style-type: none"> • If this problem persists, call for technical assistance.
# 68 Card in Printer	A card is jammed in the Print Station or card flipping area of the Printer.	Clear the jam and press the Pause button.
# 70 Multiple Feed	Multiple cards were fed into the Printer.	Verify the card thickness is set to the thickness of your cards, then press the Pause button. <ul style="list-style-type: none"> • Check for card slippage. If necessary, run the Printer cleaning routine • Verify the Cleaning roller is properly installed on the Ribbon Drawer. • Verify the cards are not sticking together.

Troubleshooting with the Error Message Table

Error Message	Cause	Solution
# 81 Unable to Feed	The Printer is unable to feed a card from the Card Hopper.	Check the following, then press the Pause button to continue. <ul style="list-style-type: none"> • Verify the Cleaning roller is properly installed on the Ribbon Drawer. • Check for card slippage. If necessary, run the Printer cleaning routine. • Verify that your cards are within the perimeters accepted card size range. Verify the cards are not sticking together.
# 82 Mag Jam	A card is jammed Magnetic station	<ul style="list-style-type: none"> • Clear any cards in the Magnetic Module. • Press the Pause button to continue.
# 91 Ribbon Out	The Print Ribbon has run out.	<ul style="list-style-type: none"> • Install a new Ribbon. • Press the Pause button to continue or the ON/OFF button to cancel.

Troubleshooting with the Error Message Table

Error Message	Cause	Solution
# 93 Wrong Ribbon	The Print Ribbon installed in the Printer does not match the Ribbon type selected in the Printer Driver.	<ul style="list-style-type: none"> • Change either the installed Print Ribbon or the Ribbon type selected in the Printer Driver. • Press the Pause button to continue or the ON/OFF button to cancel.
# 97 Ribbon Search Error	The Ribbon is not able to find the next panel correctly. Check for jams/breaks.	Recalibrate the Ribbon Sensor. <ul style="list-style-type: none"> • If broken, repair by taping the Ribbon back on to the take- up core. • Replace the Ribbon. • Press the Pause button to continue or the ON/OFF button to cancel.
# 99 Ribbon Error	The Print Ribbon has either broken or jammed.	<ul style="list-style-type: none"> • If jammed, clear the jam. • If broken, repair by taping the Ribbon back on to the take- up core. • Press the Pause button to continue or the ON/OFF button to cancel.

Troubleshooting with the Error Message Table

Error Message	Cause	Solution
# 100 Ribbon RFID Error	There is no Ribbon or the Ribbon tag information is corrupted or incorrect.	Verify the Printer Driver settings for correct Ribbon. <ul style="list-style-type: none"> • Try a new Ribbon and continue. • Press the ON/OFF button to cancel.
# 102 # 103 # 104 #3 Headlift Error	This is a problem with the Printhead Lift.	Re-start the Printer and try again. <ul style="list-style-type: none"> • If this problem persists, call for technical assistance.
# 106 Job Data Error	The print data sent to the Printer is corrupt or has been interrupted.	Check the interface cable. Select the ON/OFF button to cancel this print job and then resend the job.
# 107 Printing Error	An error was detected during printing.	Re-start the Printer and try again. <ul style="list-style-type: none"> • If this problem persists, call for technical assistance.

Troubleshooting with the Error Message Table

Error Message	Cause	Solution
# 109 # 113 Ribbon Release Error	The Printer cannot locate the next Ribbon panel in order to release the Ribbon from the card.	Ensure that the Ribbon is not stuck to the card. <ul style="list-style-type: none"> • Replace the Ribbon. • Recalibrate the Ribbon sensor. • If the Ribbon is broken, repair by taping the Ribbon back onto the take- up core and manually advance to the next panel. • Press the Pause button to continue.
# 110 Card Jam/Align error	A card is jammed in the Print Station or card flipping area of the Printer.	Clear the jam. Press the Pause button to continue.
# 111 Head Loading	An unrecoverable error has occurred during printing.	Re-start the Printer and try again. If this problem persists, call for technical assistance.
# 112 Card Jam/Align error	A card is jammed in the Print Station or card flipping area of the Printer.	Clear the jam. Press the Pause button to continue.

Troubleshooting with the Error Message Table

Error Message	Cause	Solution
# 128 Calibrate Ribbon	The Print Ribbon Sensor is out of calibration.	Calibrate the Ribbon Sensor.
# 131 Flipper Jam/ Home Error	A card has become jammed in the Printer's Flipper Table. The Flipper failed to position properly while aligning a card or flipping a card.	Clear any cards in the Flipper Table, using the buttons to move the card out. <ul style="list-style-type: none"> • Resume printing. • Re-start the Printer and retry. If problem persists call for technical assistance.
# 136 Secure Guard Print Disabled	Printing is disabled by SecureGuard until a password is received.	Re-start the Printer and retry. <ul style="list-style-type: none"> • If the problem persists, call for technical assistance.
# 139 Please Remove Ribbon	Ribbon needs to be removed.	Re-start the Printer and retry. <ul style="list-style-type: none"> • If problem persists, call for technical assistance.

Troubleshooting with the Error Message Table

Error Message	Cause	Solution
# 144 EEPROM Corrupt EEPROM Read Error	EEPROM restored with factory default values.	<ul style="list-style-type: none"> • If changes were made in the Advanced Setting Tab in the Printer Driver, click the Default button to reset these numbers. • Re-start the Printer and try again. If this problem persists, call for technical assistance.
# 170 Ribbon Calibration failed	Ribbon calibration failed.	Check for material blocking sensor and try again.
#202 Encoder not installed	<p>You are trying to send encoding data, but the Printer is not configured with this Encoder type.</p> <p>iCLASS,Prox,Mifare,SmartCard</p>	<ul style="list-style-type: none"> • Ensure that no encoding data is being sent with the print job and reprint the card. • Install an Encoding Module.
No UV Protection	Ribbon type selected does not contain an overlay or overlamine	The current printer driver setup does not have any protective coating being applied to the front or back of the card. Select YES to continue or NO to alter the settings.

Troubleshooting with the Error Message Table

Error Message	Cause	Solution
# 53 Lam Card Jam	A jam occurred somewhere between the Printer and the Laminator	Open covers and clear the obstruction/jam
# 52 Lam Generic Error	Laminator firmware error	Reset power and try again. If this problem persists call for technical assistance.
# 48 Check Lam Power	Lam is connected but not powered.	Power off the Printer, power the Laminator, and then power on the Printer. A damaged Flipper board, E-Card board, or EEPROM could potentially result in this same error.
#282 Lam Heater Off	See the next column.	If this problem persists, call for technical assistance.
#59 Lam Heater Timeout	See the next column.	If this problem persists, call for technical assistance.

Troubleshooting with the Error Message Table

Error Message	Cause	Solution
#57 Wrong Lam Type	See the next column.	Install a new film roll and press RESUME to continue or CANCEL to abort. If the problem persists, call for technical assistance.
#58 Check Lam Material	See the next column.	Install a new Lamination roll and press RESUME to continue or CANCEL to abort. If the problem persists, call for technical assistance.
#208 #209 No Lam	There is no Laminate installed or it is broken.	Check the Lamination and try again
#211 Wrong Lam Type	An incorrect Laminator film has been installed, or a driver setting is incorrect.	Install a new film roll and press RESUME to continue or CANCEL to abort. If the problem persists, call for technical assistance.
#210 Remove Lam	Driver is set for single side lamination but there are 2 rolls of laminate in the printer.	Remove the roll not used and try again.

Troubleshooting with the Error Message Table

Error Message	Cause	Solution
#53 Lam Jam	A card is jammed in the Lamination module area of the Printer.	Clear the jam according to the steps in the Troubleshooting section of the User Guide. Press QUIT to clear this message.
#60 Lam Sensor	The Lam Sensor is out of calibration.	Calibrate the Lam Sensor.
# 63 Lam Cart 1 Out Error Lam Cart 2 Out Error	There is no material loaded in the Laminator Cartridges 1 or 2.	Load material into the Laminator.

Printer Specific Tools (DTC4500)



The status icons are as follows:

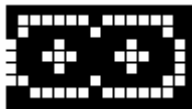

This icon indicates that the Print Ribbon supply is low and will need to be replaced soon.



This icon indicates that the Laminate in the Top Laminator is low and will need to be replaced soon.



This icon indicates that the Laminate in the Bottom laminator is low and will need to be replaced soon.



This icon indicates that the Printer needs to be cleaned. Refer to [Section 9: Cleaning](#) of the User's Manual.





This icon is only displayed for Printers with an attached Dual-Input Hopper and indicates that the Top Input Hopper is currently selected.



This icon is only displayed for Printers with an attached Dual-Input Hopper and indicates that the Bottom Input Hopper is currently selected.

Printer Specific Tools (DTC4500)

Press the  button to scroll through the details of the Printer and perform the action.

Press the  button to select the option.

Once  is selected, use the left down arrow  to scroll through the Info, Test Prints, and Languages and Exit.

Use the corner arrow  to run that option.

The curved arrow  will return to the first screen.

Additional Printer Specific Tools



Label	Description
INFO	<ul style="list-style-type: none"> • Printer Type • Firmware Version • IP Address • Flipper • Lamination • Magnetics • E-Card • Password • Card count
TEST PRINTS	<p>Color Photo: Select this to print a color card to test communication and integrity.</p> <p>Alignment: Select this to print a card used to align the print image on the card.</p> <p>Settings: Select this to print a card with the Advanced settings.</p> <p>Resin: Select this to print a RESIN test card.</p> <p>Rewritable: Select this to ERASE the Rewritable card.</p> <p>Magnetic: Select this to test Magnetic encoding. (Hi-Co only)</p> <p>Lamination: Select this to laminate a test card.</p>
Hopper Select	Ability to select which hopper to feed cards from. Applies to Dual Hopper Printers.
Toolbox	<p>Clean Printer: Select this to run the clean printer routine.</p> <p>Clean Laminator: Select this to run the clean laminator routine.</p> <p>Calibrate Mag: Select this to calibrate the Magnetic Sensor</p>

	Calibrate Rib Sensor: Select this to calibrate the ribbon sensor. Network: Select this to configure network options.
Language	Language: Select this choice to change the Printer Displayed Language.
Exit	Exit: Select this choice to exit the Printer Tool options.

Section 9: Cleaning

The Card Printer is built to require a minimum amount of maintenance. Nevertheless, there are a few procedures you can perform on a regular basis or as needed to ensure the best possible performance

Safety Messages (review carefully)

Symbol	Critical Instructions for Safety purposes
<p>Danger:</p> 	<p>Failure to follow these installation guidelines can result in death or serious injury.</p> <p>Information that raises potential safety issues is indicated by a warning symbol (as shown to the left).</p> <ul style="list-style-type: none"> • To prevent personal injury, refer to the following safety messages before performing an operation preceded by this symbol. • To prevent personal injury, always remove the power cord prior to performing repair procedures, unless otherwise specified. • To prevent personal injury, make sure only qualified personnel perform these procedures.
<p>Caution:</p> 	<p>This device is electrostatically sensitive. It may be damaged if exposed to static electricity discharges.</p> <p>Information that raises potential electrostatic safety issues is indicated by a warning symbol (as shown to the left).</p> <ul style="list-style-type: none"> • To prevent equipment or media damage, refer to the following safety messages before performing an operation preceded by this symbol. • To prevent equipment or media damage, observe all established Electrostatic Discharge (ESD) procedures while handling cables in or near the Circuit Board and Printhead Assemblies. • To prevent equipment or media damage, always wear an appropriate personal grounding device (e.g., a high quality wrist strap grounded to avoid potential damage). • To prevent equipment or media damage, always remove the Ribbon and Cards from the Printer before making any repairs, unless otherwise specified. • To prevent equipment or media damage, take jewelry off of fingers and hands, as well as thoroughly clean hands to remove oil and debris before working on the Printer.



DTC4500 Card Printer/Encoder Cleaning Kit



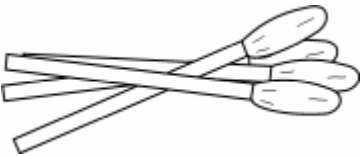
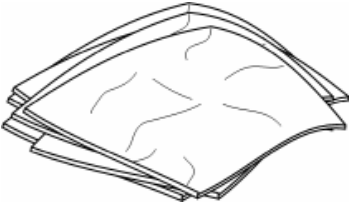

Caution: As with any electronic device, internal components of the Printer, such as the Printhead, may be damaged if exposed to static electrical discharges. To avoid potential damage, always wear an appropriate personal grounding device, such as a wrist strap (with integral resistor) connected to an ESD ground.

Supplies (included with the Cleaning Kit)

This Cleaning Kit provides you with the specialized cleaning supplies and the required cleaning procedures for you to maintain your Fargo DTC4500 Card Printer/Encoder. The following cleaning procedures will require less than ten minutes.



Description	Supplies (pictured)
<p>Four (4) Printhead Cleaning Swabs are pre-moistened with 99.99% isopropyl alcohol for cleaning your Printer's Printhead.</p>	
<p>Ten (10) Gauze Pads are pre-moistened with 99.99% isopropyl alcohol for cleaning your Printer's interior and exterior.</p>	
<p>Ten (10) Cleaning Cards are provided with adhesive backing for cleaning your Printer's Platen and Card Feed Rollers.</p>	

Printhead Cleaning

Step	Procedure
1	 Caution: Turn Off the Printer and unplug the power cord from the Printer.
2	Remove the Ribbon Drawer.
3	Open the Printhead Cleaning Swabs . Break it to moisten the tip.
4	Swab the tip back and forth across the top of the Printhead. Allow to dry thoroughly before sending a print job. 

Cleaning the Platen and the Card Feed Rollers

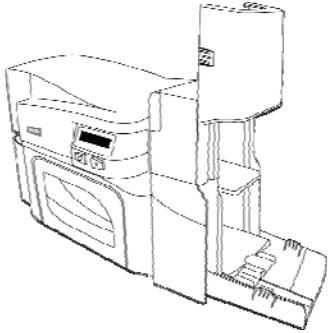
Perform this procedure approximately every **1000 prints** to maintain a consistent print quality. (**Note:** The Card Feed Rollers move the card throughout the print process. Rollers should be kept clean to prevent card jams and card contamination. This cleaning process will ultimately lead to better print quality and extended Printhead life.)

Step	Procedure
1	<p>a. Open the Printer's Ribbon Drawer and remove the Print Ribbon.</p> <p>b. Remove all the cards from the Printer's Input Hopper.</p> 
2	<p>Use the Cleaning Card from the Printer's Cleaning Kit and remove the adhesive backing from both sides of the card.</p> <p>If your Printer has a Magnetic Encoder installed, be sure to leave the small Liner Strip on top of the Cleaning Card in place.</p> <p>This small strip is needed to protect the Magnetic Head from the adhesives on the Cleaning Card.</p> 

Cleaning the Platen and the Card Feed Rollers

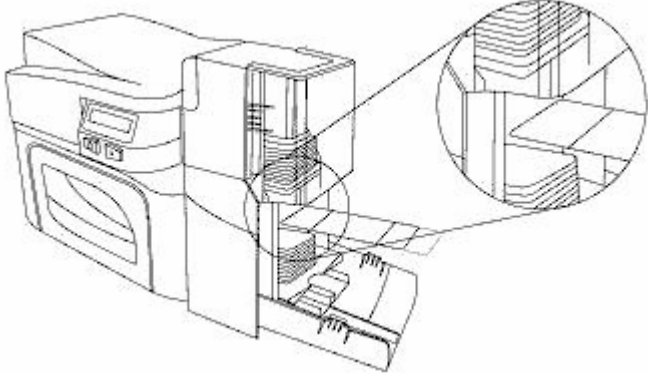
Step	Procedure
3	<p>Insert the Cleaning Card into the Single Feed Card Slot until the card stops.</p> <p>If your Printer is equipped with a Magnetic Encoder, you must insert the Cleaning Card with the printed side up and with the small Liner Strip towards the front of the Printer.</p> 
4	From your computer, open the Printer Driver and select Printing Preferences.

Cleaning the Platen and the Card Feed Rollers

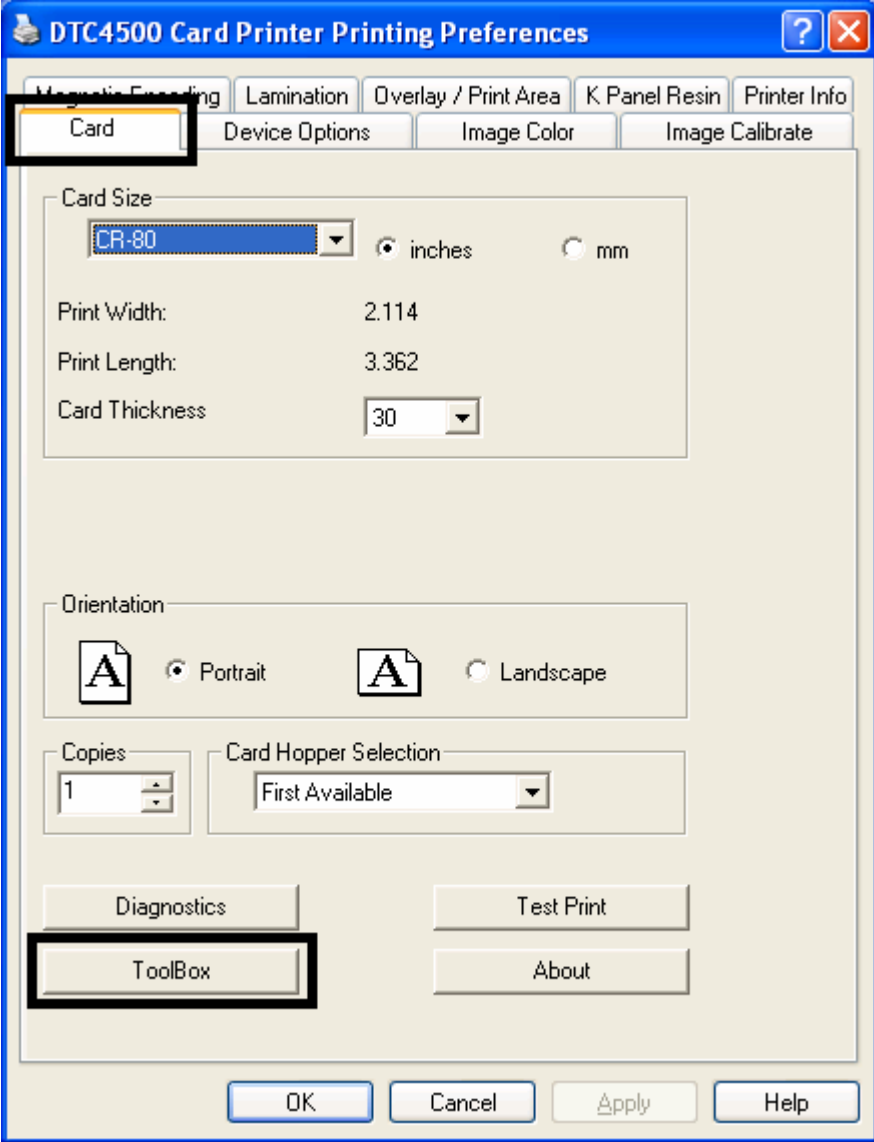
Step	Procedure
5	<p>Click on the Toolbox button.</p>  <p>The screenshot shows the 'DTC4500 Card Printer Printing Preferences' dialog box. The 'Card' tab is selected and highlighted with a black box. The 'ToolBox' button at the bottom left is also highlighted with a black box. The dialog contains the following settings:</p> <ul style="list-style-type: none">Card Size: CR-80 (dropdown), inches (radio button selected), mm (radio button unselected)Print Width: 2.114Print Length: 3.362Card Thickness: 30 (dropdown)Orientation: Portrait (radio button selected), Landscape (radio button unselected)Copies: 1 (spin box)Card Hopper Selection: First Available (dropdown)Buttons: Diagnostics, Test Print, About, Toolbox (highlighted), OK, Cancel, Apply, Help

Cleaning the Platen and the Card Feed Rollers

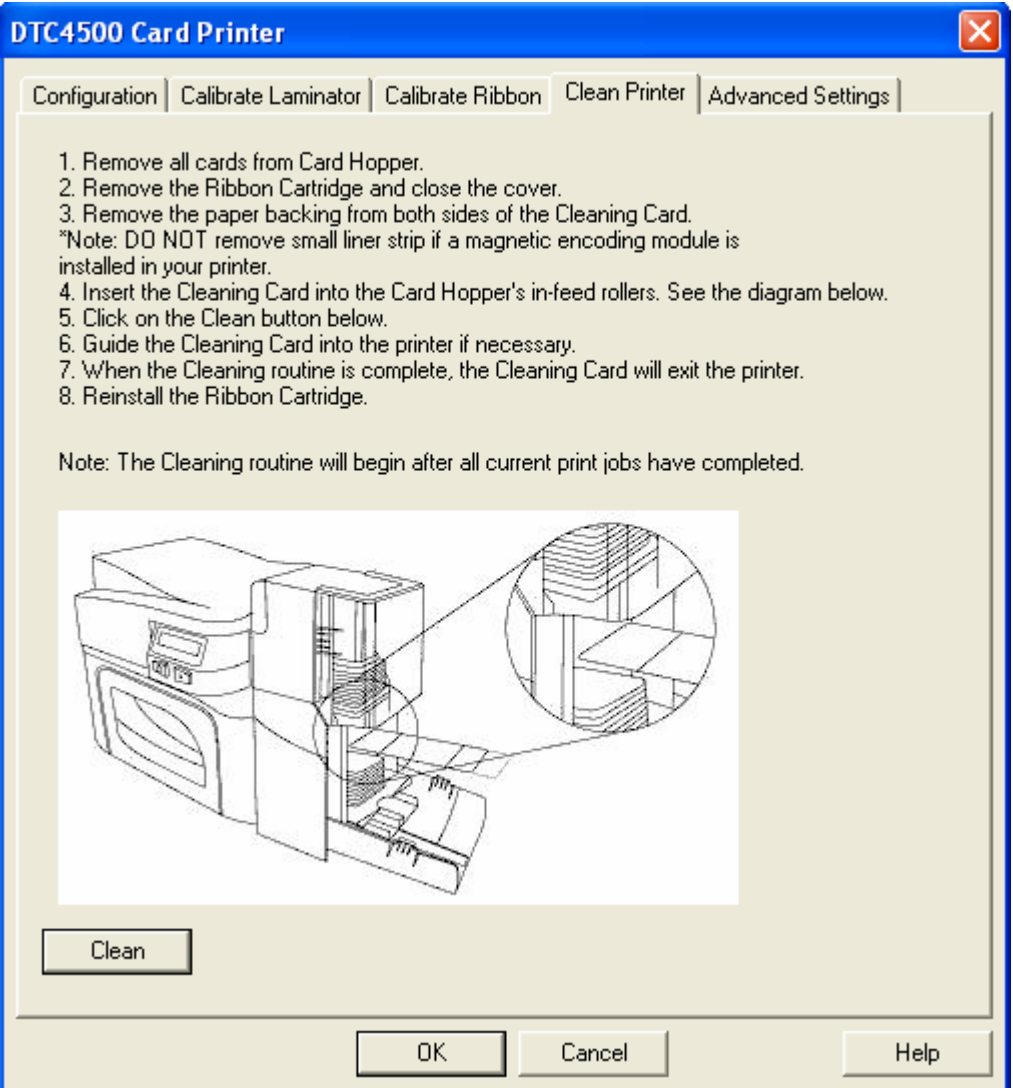
Step	Procedure
6	<p>Click on the Clean Printer button.</p>  <ol style="list-style-type: none"> 1. Remove all cards from Card Hopper. 2. Remove the Ribbon Cartridge and close the cover. 3. Remove the paper backing from both sides of the Cleaning Card. *Note: DO NOT remove small liner strip if a magnetic encoding module is installed in your printer. 4. Insert the Cleaning Card into the Card Hopper's in-feed rollers. See the diagram below. 5. Click on the Clean button below. 6. Guide the Cleaning Card into the printer if necessary. 7. When the Cleaning routine is complete, the Cleaning Card will exit the printer. 8. Reinstall the Ribbon Cartridge. <p>Note: The Cleaning routine will begin after all current print jobs have completed.</p>
7	<p>Click on the Clean button (shown above).</p> <ul style="list-style-type: none"> • The Printer will pull in the Cleaning Card. The Printer will then perform an automated cleaning procedure. • This procedure is designed to thoroughly clean the Platen and the Card Feed Rollers inside the Printer.

Cleaning the Printer's Interior

Periodically, use a **Cleaning Pad** from the Printer's **Cleaning Kit** to remove dust and other contaminants from inside the Printer. (**Note:** Dust and other particles may accumulate inside the Printer with continued usage. This can cause spots or specks to appear on the printed cards.)

Cleaning the Printer's Exterior

Clean it only with a **Cleaning Pad** from the Printer's **Cleaning Kit**. (**Note:** The Printer has a durable casing that should retain its luster and appearance for many years.)

Section 10: Firmware Upgrades

Upgrade the Printer Firmware

Step	Procedure
1	Requirements <ul style="list-style-type: none"><li data-bbox="266 554 516 583">• Internet Access<li data-bbox="266 600 870 630">• Printer is powered up and connected to PC

Upgrade the Printer Firmware

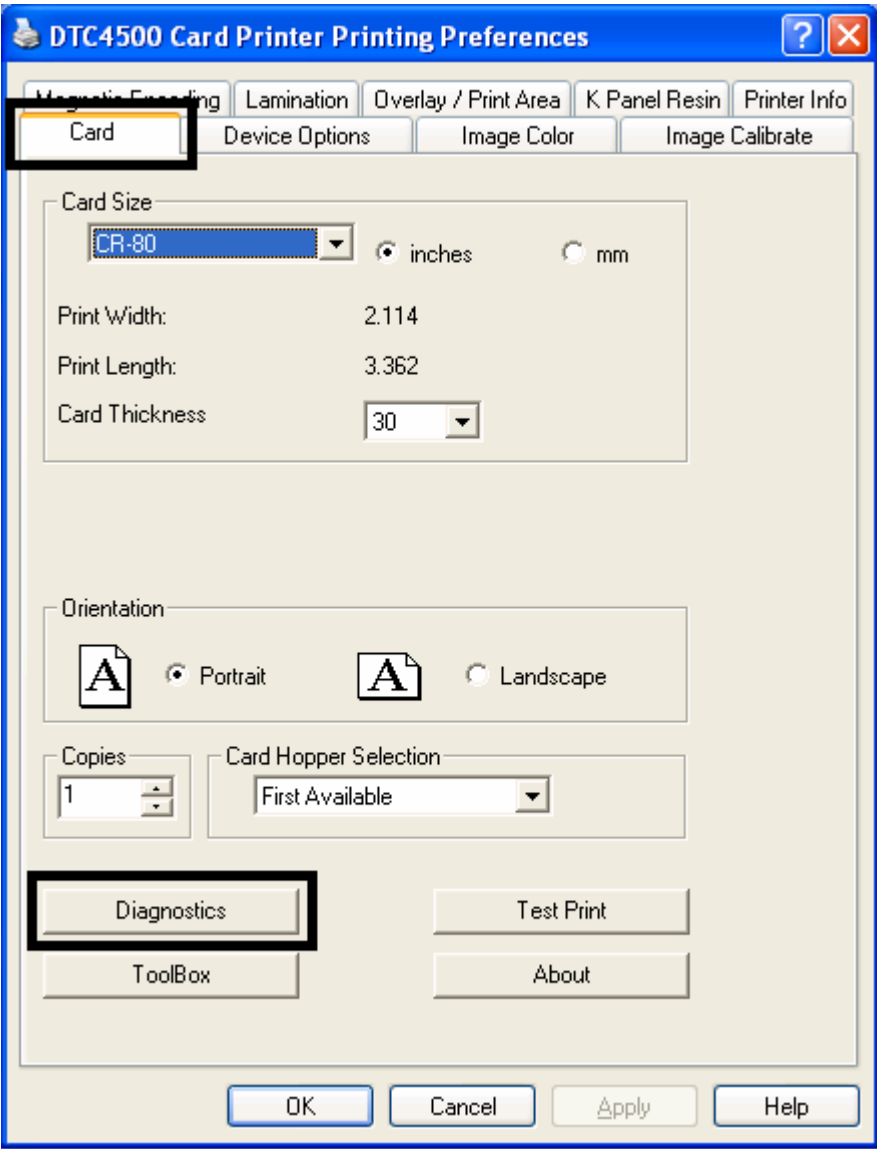
Step	Procedure
2	<p>Open the Fargo Workbench Printer Utility or use the Diagnostics button from the Card tab of the Printing Preference page. (Note: The Workbench is also available from the Fargo folder in the Windows Program folder.)</p> 

Upgrade the Printer Firmware

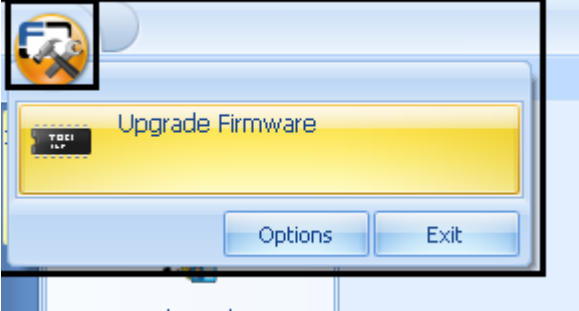
Step	Procedure
3	<p>From the Application Icon, select Upgrade Firmware.</p>  A screenshot of a software application window. In the top-left corner, there is a small icon of a printer with a gear. A yellow rectangular dialog box is open, containing the text "Upgrade Firmware" in a blue font. Below the text are two buttons: "Options" and "Exit".

Upgrade the Printer Firmware

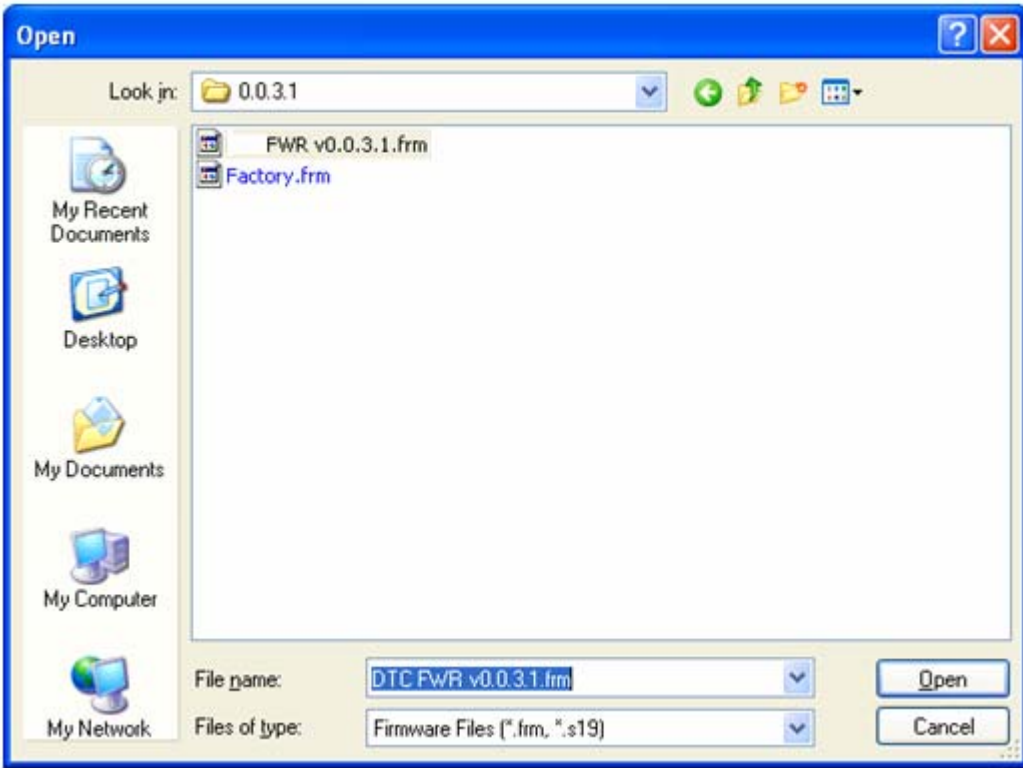
Step	Procedure
4	<p>Find the Firmware via Check for Firmware Updates at www.hidglobal.com</p> <ul style="list-style-type: none"> • Save the file to a folder. (Double-Click the file to Un-Zip the file) • Use the Browse button to find the .frm file. • Select the file. Click Open. 
5	Click on Upgrade to start the upgrade process.
6	This message will appear while Firmware is updating. Loading Firmware.
7	The Printer will reboot after this process is completed.

Section 11: HID Global Technical Support

The purpose of this section to provide you with an efficient, step-by-step procedure to be used when contacting HID GLOBAL Technical Support as needed for this Card Printer.

Step	Procedure
1	Contact the HIDGlobal Technical Support Group by phone at (866)607-7339 Ext #6 or by fax at (952) 946-8492 for additional technical assistance. OR Contact HID Technical Support via the Web: www.hidglobal.com
2	Position a phone near the Printer and Computer so the technician can help to troubleshoot the Printer(s).
3	Please have a self-test and a sample card ready when calling HID Technical Support.

Reading the Serial Numbers on a Fargo Printer

You can determine when your card Printer was manufactured by reading directly from the serial number (affixed to your card Printer).

Example	Explanation
Reviewing Example No. 1: Serial Number A9050028 (2009)	<ul style="list-style-type: none"> • A9050028: The first two digits in the serial number indicate the year the Printer was built (e.g., the digits A9 indicate the year 2009). • A9050028: The third and fourth digits in the serial number indicate the week the Printer was built (e.g., the digits 05 indicate week 5 of that year). • A9050028: The last four digits indicate the sequence number for the numeric order in which the Printers were built.
Reviewing Example No. 2: Serial Number B0050028 (2010)	<ul style="list-style-type: none"> • B0050028: The first two digits in the serial number indicate the year the Printer was built (e.g., the digits B0 indicate the year 2010). • B0050028: The third and fourth digits in the serial number indicate the week the Printer was built (e.g., the digits 05 indicate week 5 of that year). • B0050028: The last four digits indicate the sequence number for the numeric order in which the Printers were built.

Appendix A

Using the Defined Area Option

This procedure can be used with the K Panel or the Overlay /Print Area procedure to define specific areas. The K-Panel procedure is described below: The same process is used for the Overlay/Print Area option.

- Select **Defined Area(s)** for the Printer Driver to print the resin black (K) panel for all black found only in a desired and defined area or areas.
- Click **Defined Area(s)**, which will activate the card grid in the upper half of the window. It is through this card grid that up to five areas can be defined.
- Determine the area of the card necessary to define. In the sample, this area is indicated by the dashed outline.
- Determine the size of this area by actually printing a card and looking at it in the same orientation as when it exits the Printer.
- Measure the total size for the area and enter those dimensions into the dimension boxes.
- Once the area is sized properly, measure from the lower left corner of the card up and over to the lower left corner for the defined area. Enter these values into the X and Y boxes.

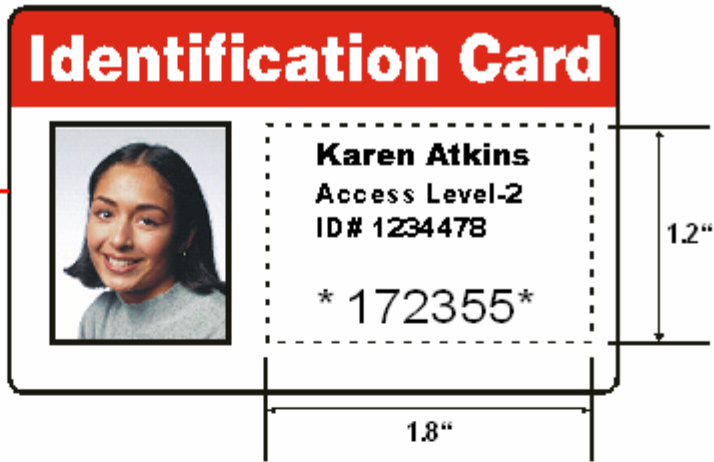

- Print the card design and note how the image is oriented on the card as it ejects from the Printer.
- Measure the defined area location based on the printed card.
- Define another area by clicking the Defined Area up arrow.
- Use the Defined Area arrows to navigate back and forth from area to area.
- Delete an area by using the Defined Area arrows to select the area.

Configuring Fluorescent Data (F-Panel for YMCFKO Ribbon) using the Workbench

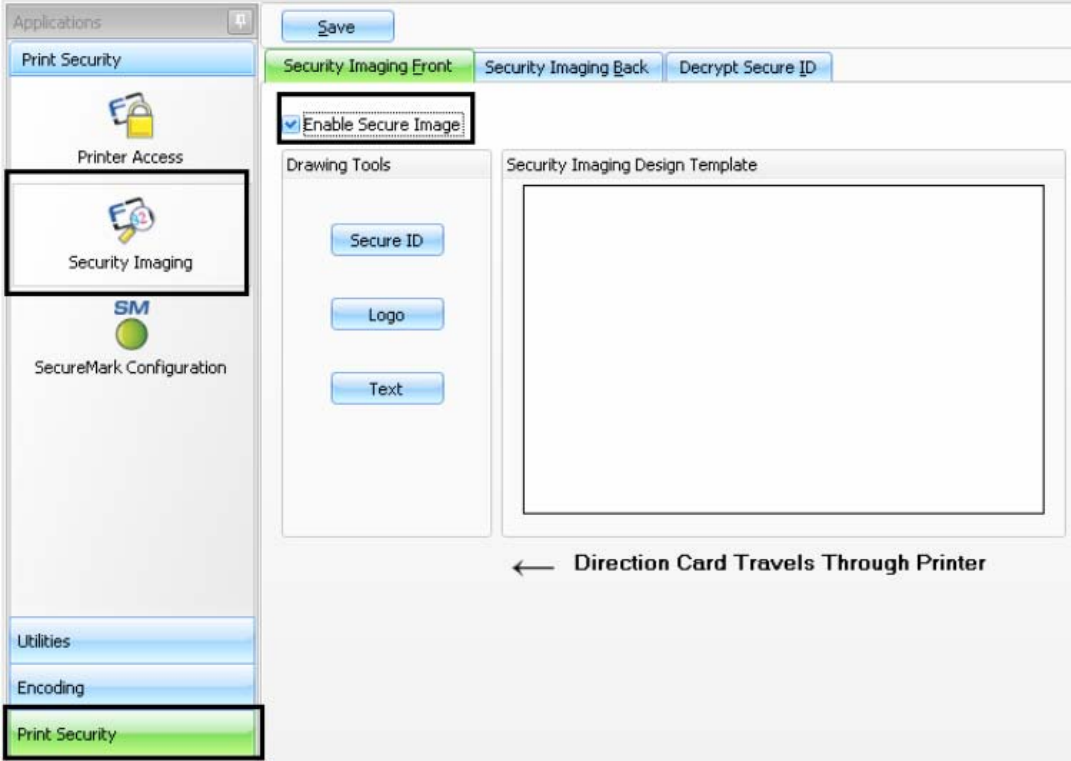
Step	Procedure
1	From the Driver Printing Preferences, click on Diagnostics to bring up the Fargo Workbench Printer Utility.
2	<p>a. Click the Print Security applet group and select the Security Imaging applet.</p> <p>b. Check the Enable Secure Imaging checkbox. (Note: The option for both front and back are set up the same way.)</p> 

Configuring Fluorescent Data (F-Panel for YMCFKO Ribbon) using the Workbench

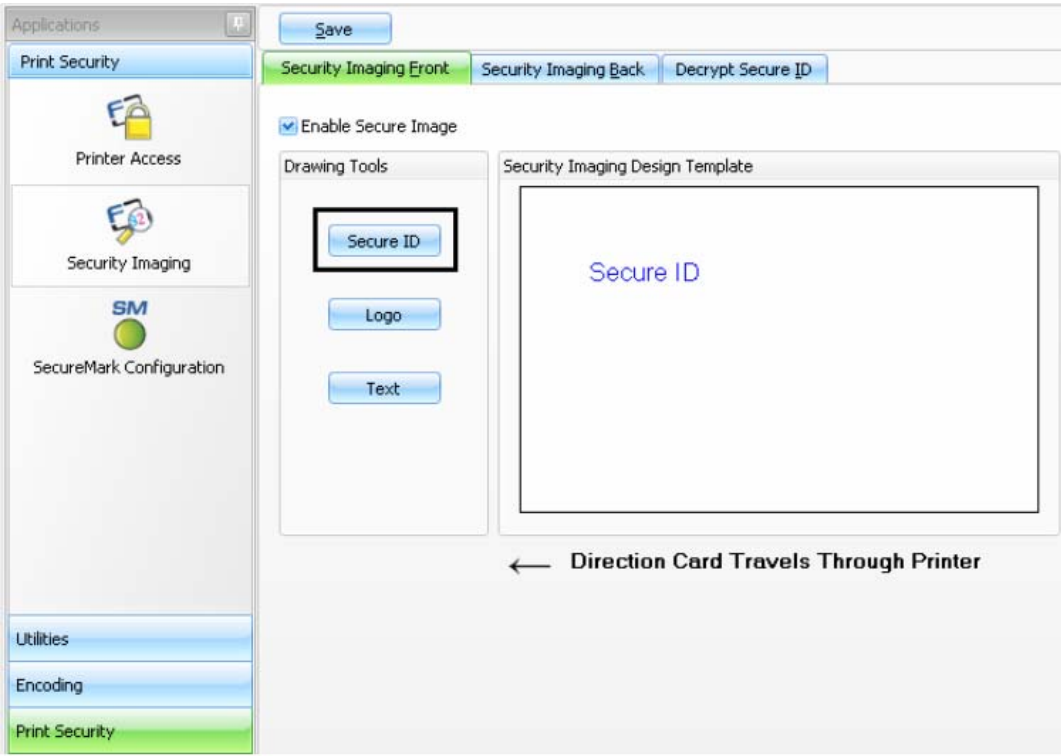
Step	Procedure
3	<p>a. Click on the Secure ID box on the left.</p> <p>b. Click and drag a box onto the Template.</p> <p>c. Move and size as needed.</p> 

Configuring Fluorescent Data (F-Panel for YMCFKO Ribbon) using the Workbench

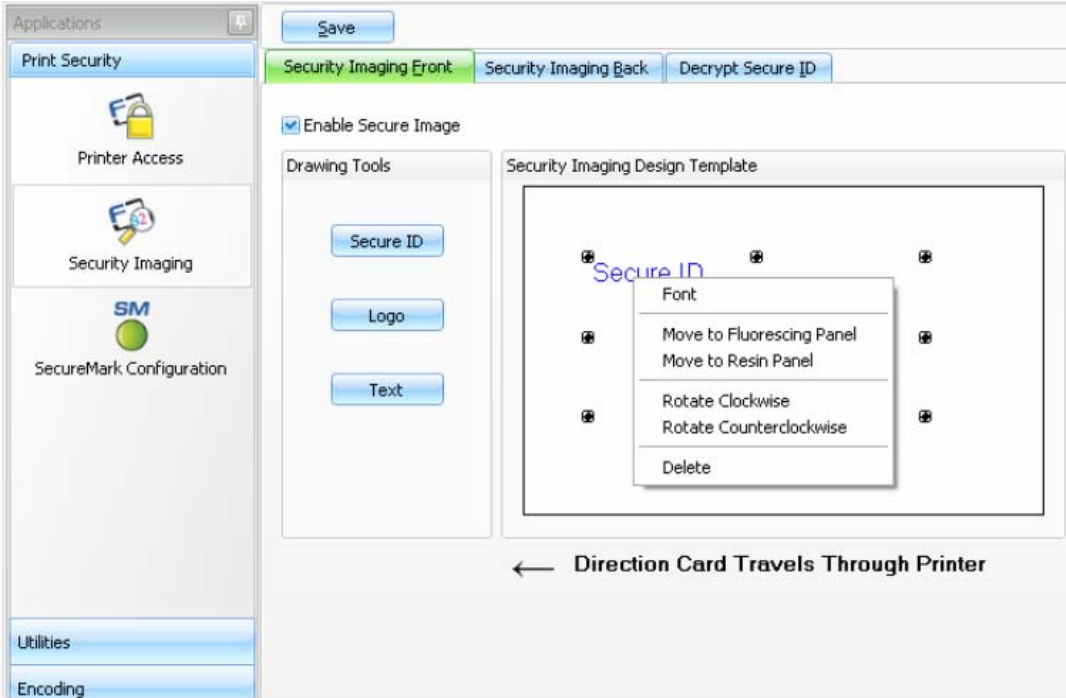
Step	Procedure
4	<p>On the Template, right click on the Secure ID box for the options.</p> 

Configuring Fluorescent Data (F-Panel for YMCFKO Ribbon) using the Workbench

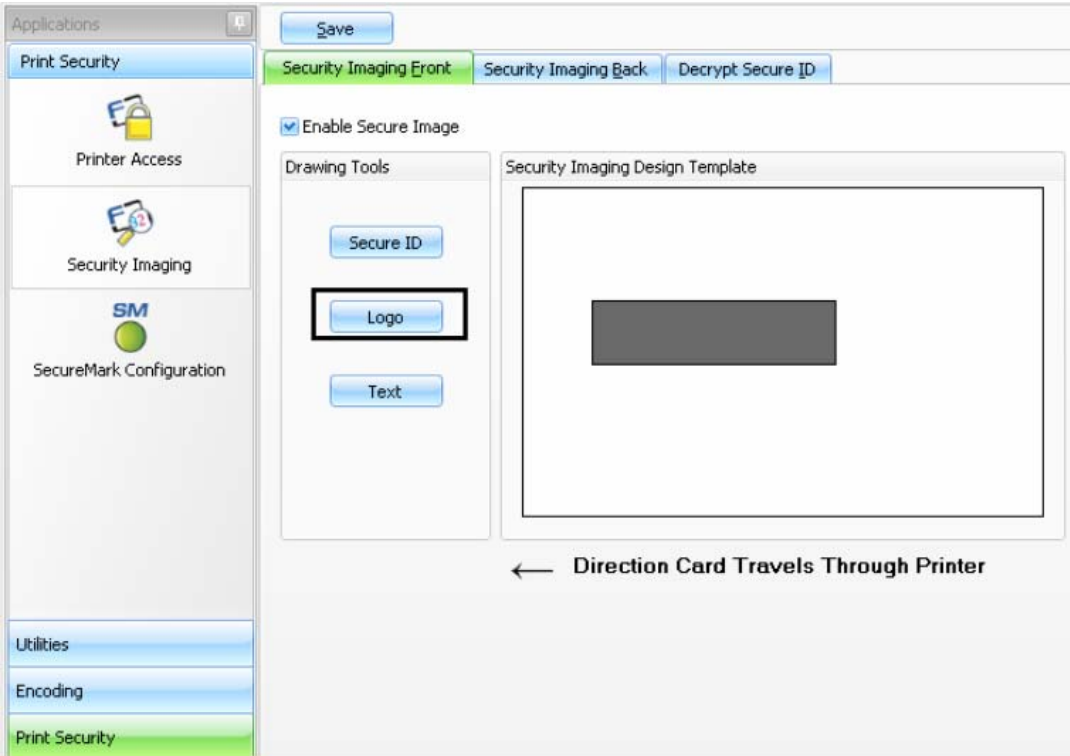
Step	Procedure
5	<p>a. Click on the Logo box on the left.</p> <p>b. Click and drag a box onto the Template.</p> <p>c. Move and size (as needed) by grabbing the corner of the box.</p> 

Configuring Fluorescent Data (F-Panel for YMCFKO Ribbon) using the Workbench

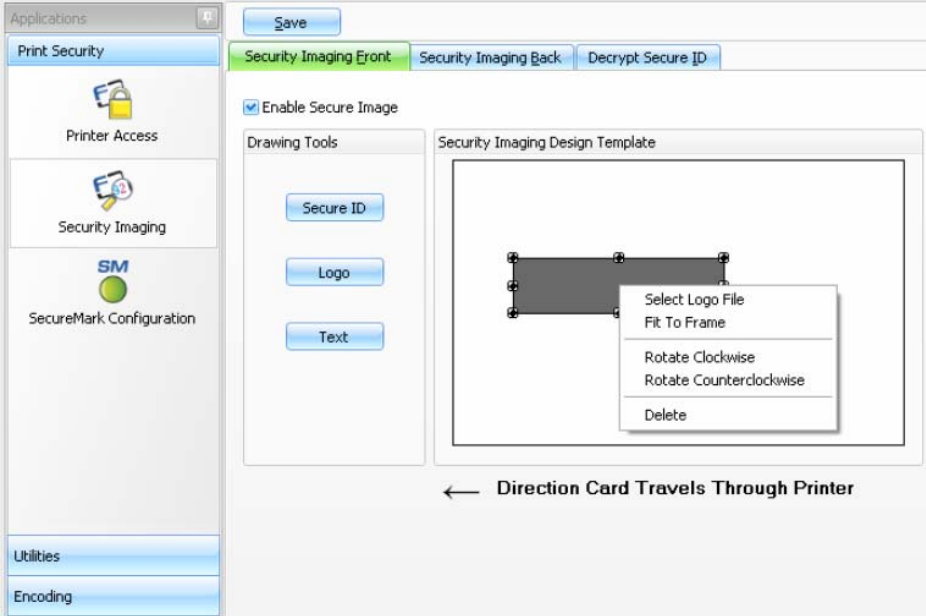
Step	Procedure
6	On the Template right click on the Logo box for the options shown below.
7	<p>Select the Logo File.</p> <p>Find the source of the Logo to place on the card. (Note: Fit to Frame will size the image to fit the box. Once this is set up, this logo will print from the software program. This is set up in the background.)</p> 

Configuring Fluorescent Data (F-Panel for YMCFKO Ribbon) using the Workbench

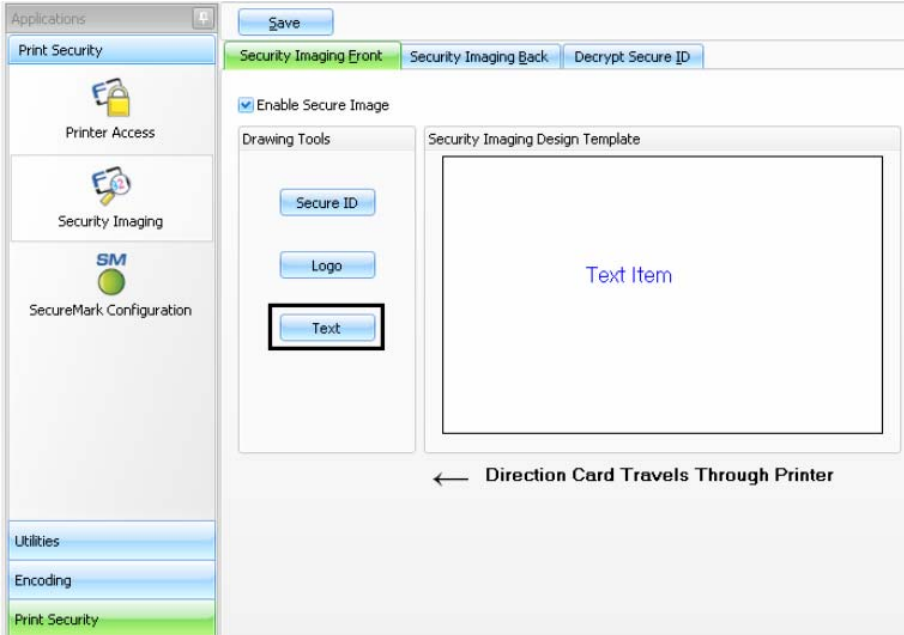
Step	Procedure
8	<p>a. Click on the Text box on the left.</p> <p>b. Click and drag a box onto the Template.</p> <p>c. Move and size as needed.</p> 

Configuring Fluorescent Data (F-Panel for YMCFKO Ribbon) using the Workbench

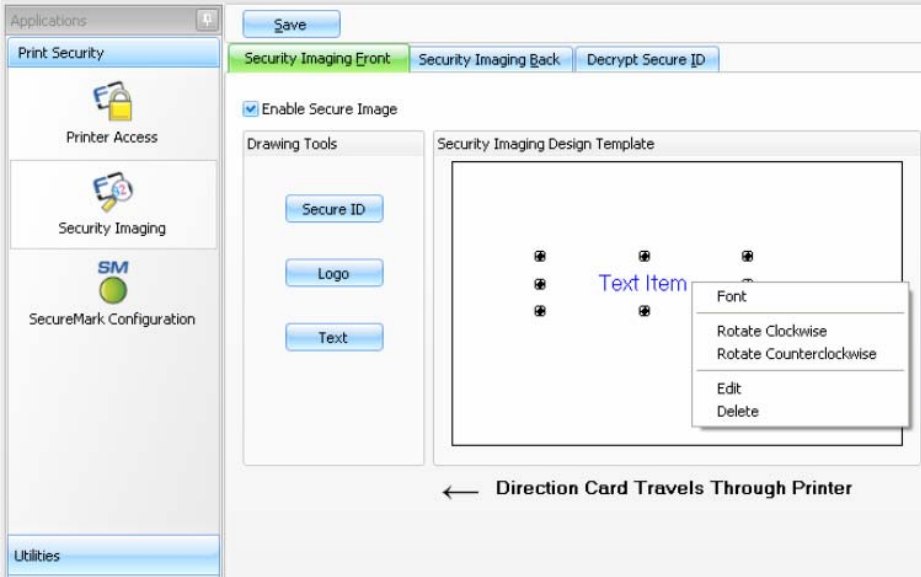
Step	Procedure
9	<p>On the Template, right click on the Text box for the options.</p> 

Configuring Fluorescent Data (F-Panel for YMCFKO Ribbon) using the Workbench

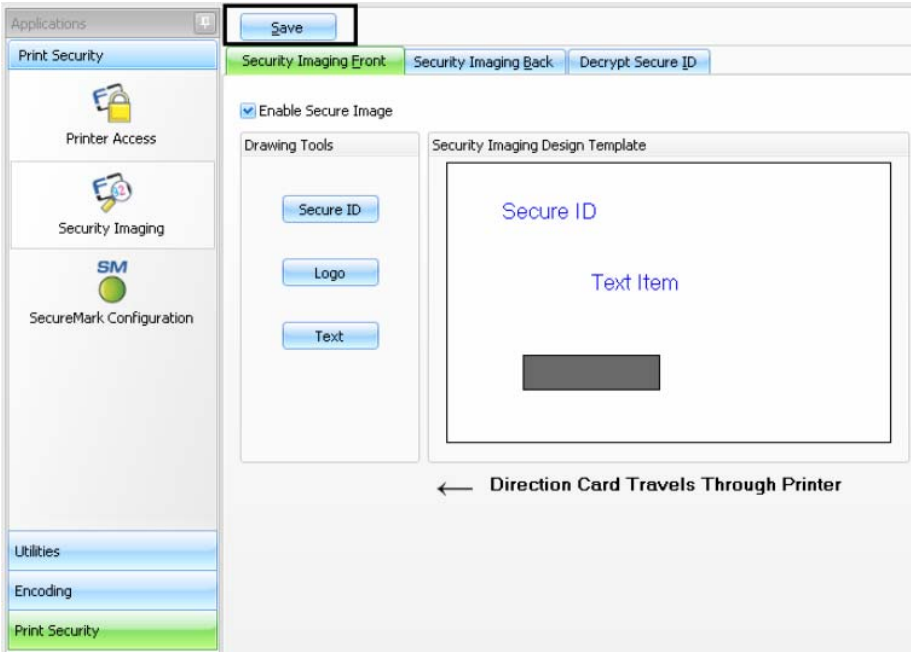
Step	Procedure
10	Follow the same instruction as above for the back side of the card.
11	<p>a. Save this template using the Save button</p> <p>b. Close the Workbench. (Note: Any Software program file printed with the YMCFKO Ribbon installed into the Printer will print this design with the F-Panel of the Ribbon. It will print the same file each time unless you recreate a new template.)</p> 

Configuring Fluorescent Data (F-Panel for YMCFKO Ribbon) using the Workbench

Step	Procedure
12	Set the Ribbon for YMCFKO in the Printing Preferences. (Note: The Automatically detect the installed Ribbon for every print job button may also be used. The F-Panel Ribbon must be installed for this process to work.)
13	<p>Check Invert F-Panel Image to create a negative of the fluorescent image.</p> <ul style="list-style-type: none">• This refers to the ability to cause light or white areas of the image to fluoresce and dark colors to remain dark on the printed card when exposed to a UV light.• The fluorescent dye color is bright when black light is applied to it.• By default, the dark areas of the image will fluoresce on the card and the lighter or white areas will have no dye applied. (Note: This may improve the look of the person's image if used for the Logo.)

Configuring Fluorescent Data (F-Panel for YMCFKO Ribbon) using the Workbench

